

SteppIR™ **Antenna Systems**

MonstIR

INSTALLATION INSTRUCTIONS



SteppIR Antennas

2112 - 116th Ave NE, Suite 2-5 - Bellevue, WA 98004

Tel: 425-453-1910 Fax: 425-462-4415

Tech Support: 425-891-6134

www.steppir.com

Revision 08/04/08

Abbreviations

EHT	Element Housing Tube
EHU	Element Housing Unit
EST	Element Support Tube (pole)
FCC	Flexible Connection Coupler (rubber)

EHT



EHU

FCC



EST

SteppIR Antenna Information Web Sites (as of 4/09/07)

<http://steppir.com/>

<http://groups.yahoo.com/group/steppir/>

SteppIR - Why Compromise?

The SteppIR antenna was originally conceived to solve the problem of covering the six ham bands (20m, 17m, 15m, 12m, 10m and 6m) on one tower without the performance sacrifices caused by interaction between all of the required antennas.

Yagis are available that cover 20 meters through 10 meters by using interlaced elements or traps, but do so at the expense of significant performance reduction in gain and front to back ratios. With the addition of the WARC bands on 17m and 12m, the use of interlaced elements and traps has clearly been an exercise in diminishing returns.

Obviously, an antenna that is precisely adjustable in length while in the air would solve the frequency problem, and in addition would have vastly improved performance over existing fixed length Yagis. The ability to tune the antenna to a specific frequency, without regard for bandwidth, results in excellent gain and front to back at every frequency.

The SteppIR design was made possible by the convergence of determination and high tech materials. The availability of new lightweight glass fiber composites, Teflon blended thermoplastics, high conductivity copper-beryllium and extremely reliable stepper motors has allowed the SteppIR to be a commercially feasible product.

The current and future SteppIR products should produce the most potent single tower antenna systems ever seen in Amateur Radio! We thank you for using our SteppIR antenna for your ham radio endeavors.

Warm Regards,

Mike Mertel

*Michael (Mike) Mertel - K7IR
President*



SteppIR Design

Currently, most multi-band antennas use traps, log cells or interlaced elements as a means to cover several frequency bands. All of these methods have one thing in common—they significantly compromise performance. The SteppIR™ antenna system is our answer to the problem. Yagi antennas must be made a specific length to operate optimally on a given frequency.

So, instead of trying to “trick” the antenna into thinking it is a different length, or simply adding more elements that may destructively interact, why not just change the antenna length? Optimal performance is then possible on all frequencies with a lightweight, compact antenna. Also, since the SteppIR can control the element lengths, a long boom is not needed to achieve near optimum gain and front to back ratios on 20 - 10 meters.

Each antenna element consists of two spools of flat copper-beryllium tape conductor (.54” Wide x .008” Thick) mounted in the element housing unit. The copper-beryllium tape is perforated to allow a stepper motor to drive them simultaneously with sprockets. Stepper motors are well known for their ability to index very accurately, thus giving very precise control of each element length. In addition, the motors are brushless and provide extremely long service life.

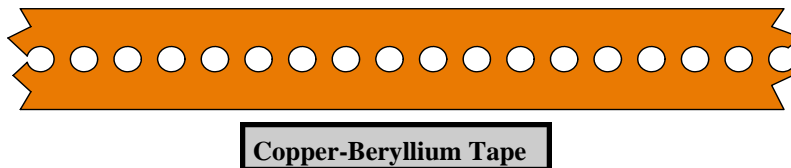

The copper-beryllium tape is driven out into a hollow fiberglass elements support tube (see below), forming an element of any desired length up to the limit of each specific antenna model (a vertical uses only one side). The fiberglass elements support tubes (poles) are telescoping, lightweight and very durable. When fully collapsed, each one measures approximately 57” in length. Depending on the model, there may be additional extensions added to increase the overall element length.

The ability to completely retract the copper-beryllium antenna elements, coupled with the collapsible fiberglass poles makes the entire system easy to disassemble and transport.

The antenna is connected to a microprocessor-based controller (via 22 gauge conductor cable) that offers numerous functions including dedicated buttons for each ham band, continuous frequency selection from 80m to 6m (depending on the model). There are also 17 ham and 6 non-ham band memories and you can select a 180° direction reversal* or bi-directional* mode and it will adjust in just about 3 seconds (* Yagi only).

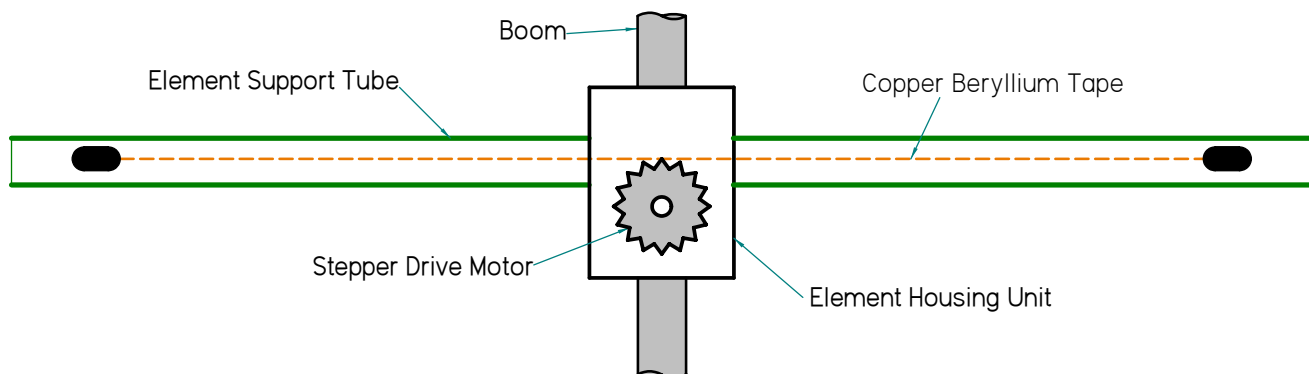



**JÜRIG DR. REGLI (HB9BIN)
SWITZERLAND**

<h2>Table of Contents</h2>	
<u>Topic</u>	<u>Page</u>
Abbreviations	2
Why Compromise	3
SteppIR Design	4
Table of Contents	6
Parts List	7
Word of Caution	12
Installing Boom to Mast	13
Boom Assembly	15
Element Bracket Assembly	18
Install the Boom Truss	22
Element Truss Assembly	25
Assemble 70' Elements	26
Wiring Elements	30
Prepare the Telescoping Fiberglass Element Support Tubes (EST)	35
Installing the Fiberglass Element Support Tubes (EST)	38
Installing Element Trusses	39
6m Passive Element Installation (Optional)	40
SteppIR Performance Topics	42
SteppIR Warranty	45



HB9BIN Assembly Crew

ITEM	QTY	SIZE	DESCRIPTION
BOX 1	1	36x19x12	ELEMENT BOX
BOX 2	1	19x19x6	MASTER PLATE BOX
BOX 3	1	60x3x6	TELESCOPING POLE BOX
BOX 4	1	81x11x7	BOOM BOX
BOX 5	1	108x6x4	FIBERGLASS POLE BOX
BOX 6	1	108x6x4	FIBERGLASS POLE BOX
BOX 7	1	60x3x6	OPTIONAL 6M PASSIVE BOX
BOX 8+	?	?	ANYTHING ADDITIONAL

ITEM	QTY	PART NUMBER	DESCRIPTION
IN BOX 1	1		MonstIR INSTALLATION MANUAL
	1	72-0009-03	GLUE KIT (CPVC - PRIMER / GLUE)
	1		OPERATORS MANUAL
	2		SteppIR STICKERS
	1		40M ELEMENT HOUSING UNIT (DRIVEN)
	2		40M ELEMENT HOUSING UNIT (PASSIVE)
	1		16 CONDUCTOR CONTROL CABLE
BRACKET ASSEMBLY			
	3	10-1405-01	ELEMENT SUPPORT PLATE (FOR 40m ELEMENTS)
	3	70-1414-11	TRUSS ASSY, ELEMENT SUPPORT ("A" FRAME)
	3	10-1416-L	TRUSS ASSY, ELEMENT CENTER SUPPORT (LEFT)
	3	10-1416-R	TRUSS ASSY, ELEMENT CENTER SUPPORT (RIGHT)
MAST PLATE ASSEMBLY			
	2	10-1021-31	15" x 15" MAST PLATE
	4	60-0027	1/4-20 x 1" SS BOLT
	4	60-0030	1/4-20 SS NYLOK NUT
BOOM TRUSS MAST — ASSEMBLED & STRETCH-WRAPPED			
	1	10-1430-01	BOOM TRUSS MAST (1-3/4 x 32")
	1	60-0065	5/16-18 x 3-1/2" SS BOLT
	4	60-0034	5/16" WASHER
	1	60-0046	5/16-18 SS NYLOK NUT
	2	60-0070	3/8-16 x 6" GALVANIZED TURNBUCKLE (BOOM TRUSS)

SteppIR Antennas — MonstIR

8

ITEM	QTY	PART NUMBER	DESCRIPTION
IN BOX 1			
MAST PLATE ASSEMBLY			
BAG 1		72-0010-01	
	1	60-0085	3/8-24 x 3" SS THREADED BOLT
	3	60-0050	3/8-24 SS NYLOK NUT
	4	60-0034	3/8" SS WASHER
BAG 2		72-0010-02	
	2	60-0007	2-3/4" U-BOLT & SADDLE
	4	60-0050	3/8-24 SS NYLOK NUT
BAG 3		72-0010-03	
	2		1-3/4" U-BOLT (3-5/8" LONG REACH)
	2		1-3/4" U-BOLT SADDLE
	4	60-0046	5/16" SS NYLOK NUT
BAG 4		72-0010-04	
	16	60-0045-14	1/4" WIRE CLIP (FOR PHILLYSTRAN - BOOM TRUSS)
	4	60-0073	5/16" THIMBLE
	4	60-0044-20	1/4" PLASTIC END CAPS (FOR PHILLYSTRAN)
BAG 5		72-0010-05	
	1	10-1102-21	CONTROL WIRING TERMINAL PROTECTIVE HOUSING
	2	60-6000-40	HOSE CLAMP (4")
	2	20-6016-8	8 - POSITION TERMINAL STRIP
	1	20-6016-1	1 - POSITION TERMINAL STRIP
	2	10-1029-01	CONNECTOR PROTECTOR (CREAM - IN BLUE POUCH)
BAG 6		72-0010-06	
	4	10-1421-01	2" SADDLE (SOLID) - WITH CENTER HOLE
	4	60-0072	#10-32 x 1" SS PAN-HEAD SCREW
	4	60-0019	#10-32 SS NYLOK NUT
	4		2" U-BOLT ONLY (4" LONG REACH)
	8	60-0046	5/16-18 SS NYLOK NUT
IN BOX 1	1	60-0035-10	3/8" x 151" PHILLYSTRAN (FOR BOOM TRUSS)
	1	60-0035-10	3/8" x 164" PHILLYSTRAN (FOR BOOM TRUSS)

ITEM	QTY	PART NUMBER	DESCRIPTION
IN BOX 1			
POLE ASSEMBLY HARDWARE			
BAG 1		72-0012-01	
	6	10-1114-01	COUPLER (3/4" CPVC)
BAG 2		72-0012-02	
	12	10-1429-21	ELEMENT TRUSS CLAMP HALF
	24	60-0027	1/4-20 x 1" SS BOLT
	24	60-0030	1/4-20 SS NYLOK NUT
BAG 3		72-0012-03	
	6	60-0004-01	2" U-BOLT (3.5" LONG REACH) w/ SADDLE
	12	60-0046	5/16-18 SS NYLOK NUT
BAG 4		72-0012-04	
	6	60-1006-01	QUICK DISCONNECT BOOT (1.5" TO 1.25") (FERNCO)
BAG 5		72-0012-05	
	2	60-1006-01	QUICK DISCONNECT BOOT (1.5" TO 1.25") (FERNCO)
	6	60-1006-21	QUICK DISCONNECT BOOT (1.5" TO 1.25") (MISSION)
BAG 6		72-0012-06	
	2	09-0003	SILICONE TAPE (20-FT ROLL)
	1	09-0004	SILICONE TAPE (10 FT ROLL)
	2	09-0001	ELECTRICAL TAPE (3/4" x 66' ROLL)
	6	60-0008	#2 x .25 COUPLER SCREW (INSTALLS AT THE HOUSING)
BOOM ASSEMBLY HARDWARE			
		72-0015-03	BOOM TRUSS MAST ASSEMBLY
BAG	3	60-0037	5/16-18 x 4-3/8" GALVANIZED EYEBOLT
	1		ANTI-SEIZE (IN SYRINGE)
	3	60-0067	3/8-16 x 4-1/4" SS BOLT
	3	60-0050	3/8-16 NYLOK NUT
	60	60-0041	1/4" FLAT WASHER
	9	60-0091	1/4-20 x 3-3/4" SS BOLT
	6	60-0100	1/4-20 x 3-1/2" SS BOLT
	15	60-0030	1/4-20 SS NYLOK NUT
	3	60-0046	5/16-18 NYLOK NUT
	6	60-0034	3/8" FLAT WASHER

SteppIR Antennas — MonstIR

10

ITEM	QTY	PART NUMBER	DESCRIPTION
IN BOX 2	1		20M ELEMENT HOUSING UNIT (PASSIVE)
	1		CONTROLLER
	1		POWER SUPPLY (FOR CONTROLLER)
	1		“T” SHIRT (FOR YOU)
BRACKET HARDWARE			
BAG 1		72-0011-01	
	12	10-1406-11	2-1/8” SADDLE (MACHINED SOLID-SHORT)
	12	60-0067	3/8-16 x 4-1/4” SS BOLT
	12	60-0050	3/8-16 SS NYLOK NUT
BAG 2		72-0011-02	
	12	10-1406-21	2-1/8” SADDLE (MACHINED SOLID-TALL)
	12	60-0067	3/8-16 x 4-1/4” SS BOLT
	12	60-0050	3/8-16 SS NYLOK NUT
BAG 3		72-0011-03	
	18	60-0068	1/4-20 x 1” SS FLATHEAD PHILLIPS SCREW
	3	60-0053	1/4-20 x 2.5” SS BOLT
	6	60-0078	1/4-20 x 1.75” SS BOLT
	27	60-0030	1/4-20 SS NYLOK NUT
	12	60-0034	1/4” SS WASHER
BAG 4		72-0011-04	
	6	60-0083	1/4-20 x 4” SS TURNBUCKLE (FOR ELEMENT TRUSS)
BAG 5		72-0011-05	
	6	60-0035	3/16” x 14’ PHILLYSTRAN (FOR ELEMENT TRUSS)
BAG 6		72-0011-06	
	48	60-0045	3/16” WIRE CLIP (FOR PHILLYSTRAN - ELEMENT TRUSS)
	12	60-0048	3/16” THIMBLE
	12	60-0044	3/16” PLASTIC END CAP (FOR PHILLYSTRAN)
BAG 7		72-0011-07	
	8	60-0061	#10-32 x 7/8” PAN-HEAD PHILLIPS SCREW
	18	60-0072	#10-32 x 1-1/4” PAN-HEAD PHILLIPS SCREW
	16	60-0017	#10-32 x 3/4” PAN-HEAD PHILLIPS SCREW
	26	60-0018	#10 SS WASHER
	42	60-0019	#10-32 SS NYLOK NUT
IN BOX 3	8	10-1013-01	TELESCOPING POLE (18 FOOT - 4 SEGMENT - FIBERGLASS)

SteppIR Antennas — MonstIR

11

ITEM	QTY	PART NUMBER	DESCRIPTION
IN BOX 4			
BOOM ASSEMBLY			
		72-0024-05	BOOM ASSEMBLY (6 PRE-ASSEMBLED SUB-SECTIONS)
NOTE:		MOST HARDWARE BELOW IN PRE-ASSEMBLED SUB-ASSEMBLIES	
	2	10-1425-01	2.75" x 72" SECTION
	2	10-1426-01	2.5" x 72" SECTION (END)
	1	10-1426-11	2.5" x 72" SECTION
	1	10-1426-21	2.5" x 63" SECTION
	2	10-1428-01	2.25" SPLICE
	1	10-1427-01	2.5" SPLICE (CENTER)
	1	10-1017-51	BRACKET (FOR 20m PASSIVE)
	3	10-1404-01	BRACKET (FOR TRUSS ASSEMBLY)
	9	60-0067	3/8-16x4 1/4" SS BOLT
	9	60-0050	3/8-16" SS NYLOK NUT
	6	60-0029	1/4-20 x 3" SS BOLT
	12	60-0063	1/4-20 x 3-1/4" SS BOLT
	2	60-0032	1/4-20 x 3-1/2" SS BOLT (20m BRACKET)
	11	60-0030	1/4-20" SS NYLOK NUT
	2	10-1430	2.5-MIR BOOM COUNTERWEIGHT
	5	60-0091	1/4-20x 3/4" SS BOLT
	36	60-0041	1/4" FLAT WASHER
	12	60-0100	1/4-20x3 1/2" SS BOLT
	9	60-0102	3/8-16x3/4 TYPE FTCS BLACK OXIDE BOLT
	18	60-0034	3/8 FLAT WASHER
IN BOX 5&6 ==> ** BOX 5 & 6 HAVE IDENTICAL CONTENTS **			
2 in. FIBERGLASS TUBE ASSEMBLY			
	6	10-1408-02	FIBERGLASS ELEMENT SUPPORT TUBE
	6	10-1407-11	ELEMENT PROTECTION SLEEVE (2.1" x 3.75" ALUMINUM)
	6	10-1407-21	ELEMENT PROTECTION SLEEVE (2.1" x 2" ALUMINUM)
	6	10-1409-01	SPLICE (2" TO 1.75")
1.75" FIBERGLASS TUBE ASSEMBLY			
	6	10-1411-01	1.75" x 99" FIBERGLASS ELEMENT SUPPORT TUBE
	6	10-1410-01	SPLICE (1.75" TO 2")
	6	10-1034-21	EST RING (.4")
	6	10-1412-02	ELEMENT GUIDE INNER (3/4" x 105.5" CPVC W/COUPLER)
	6	10-1413-01	ELEMENT GUIDE CHAMFERED (3/4" x 102" CPVC)
IN BOX 7	1		6-METER PASSIVE KIT - LONG (112.0") (OPTIONAL)
	1		6-METER PASSIVE KIT - SHORT (104.5") (OPTIONAL)

Word of Caution

Be Careful to avoid making contact with power lines or other potential hazards when constructing, moving and installing the antenna, as you could be seriously injured or even killed if a metal object comes in contact with high voltage.

Assembling the Antenna

It is highly recommended that you read these assembly instructions in their entirety before assembling the antenna. Doing so will provide you an overall idea of what needs to be done and helps avoid making time-consuming mistakes. Building your SteppIR is a straightforward process. It entails:

- Lubricate all fasteners ¼” or larger with anti-seize grease (in syringe)
- Determine how you will raise the antenna.
- Assembling the boom-to-mast plate and mounting it to a temporary mast.
- Assembling the boom.
- Attach the boom to the boom-to-mast plate.
- Assemble three large element brackets.
- Attach four element housings and routing control lines.

Methods to Raise the Antenna

The MonstIR is to be raised with the boom to mast plate attached. To facilitate easy attachment to the mast on the tower the 2” u-bolt saddles are bolted to the mast plate so all you have to do is slip on the four u-bolts and install the nylock nuts. The boom truss is supported by a provided 1 ¾” O.D. x 32” aluminum tube that is attached with u-bolts to the mast plate. This allows you to mount the antenna at the very top of your mast and raise the antenna completely assembled. There are many ways to raise an antenna so this is just a suggestion, however we have found it to work very well. So if you like our method, follow the instructions as they appear.

Installing Boom to Mast

- Erect a temporary mast that is about 4 feet tall to build the antenna on.

Picture 1

ways to temporarily assembling flat on the up the element be able to directly. The enough to hold safely, even balanced. You your tower if room around it 3 feet into the ground and pack soil tightly around it.



Picture 1

shows one of many rarely mount the mast bly. We strongly recommend against building it lay-ground. You will ding housings and you won't just the trusses cor-mast must be strong the 260 lb antenna when it is slightly un-could use one leg of you have adequate or bury a 2" pipe about

The mast plate consists of two identical pieces, each 15" x 15" x .250" thick and comes already bolted together. The mast plate has 33 pre-drilled holes. The four 2" u-bolt holes are used to secure the antenna to the mast on your tower. The optional pilot holes are there in the event you are using a 2-1/2" mast. If you are using a 2" mast, these holes are left unused. The two 2³/₄" u-bolts are used for attaching the boom to the mast plate. (**Picture 2 & Picture 3**)

- The **Ez-eye** is shown highlighted in **Picture 3**, near the middle of the mast plate. This system serves two purposes;
 - The primary purpose is to positively secure the boom to the mast plate preventing any rotation of the boom during high winds.
 - The second is to allow precise leveling of the antenna before tightening the 2 ³/₄" u-bolts that secure the boom.

See **Picture 4** and **Picture 4.1** for details on mounting the 3/8"x3" bolt, the three 3/8" Nylok nuts, and the four 3/8" flat washers. Install just the 3/8"x3" bolt as shown before mounting the mast plate to the temporary mast.

- Locate:
 - 4 - 2" aluminum saddles
 - 4 - #6-32x1" machine screws
 - 4 - #6-32 Nylok nuts

Mount the saddles as shown in **Picture 2**. Be aware that the mast saddles mount on the opposite side from the boom.

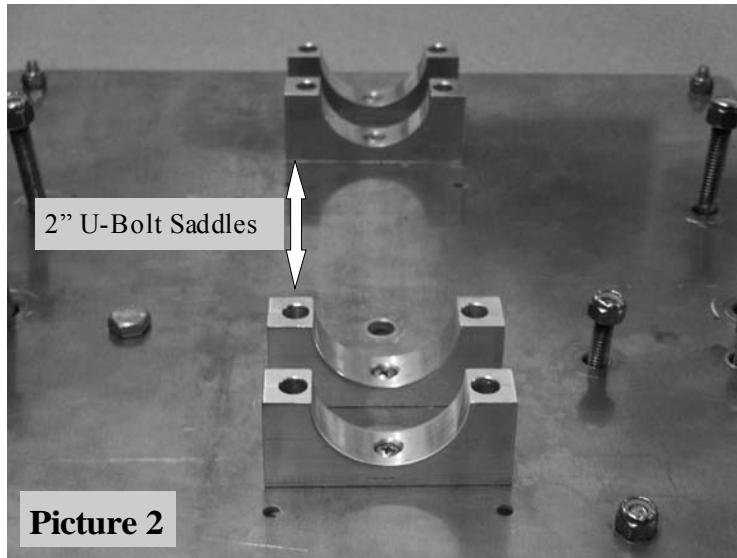

[Attach the Boom-to-Mast Plate to the Temporary Mast](#)

NOTE: Take the time now to make sure all of the 2" u-bolts will easily fit the mast plate holes, bend as required, you will be glad when you are up on the tower!

Mount the assembled plate to your temporary mast, as shown in **Picture 3**, at a convenient height for assembly purposes using the four 2" u-bolts. Pay attention to the orientation when mounting it, as the plate is not symmetrical.

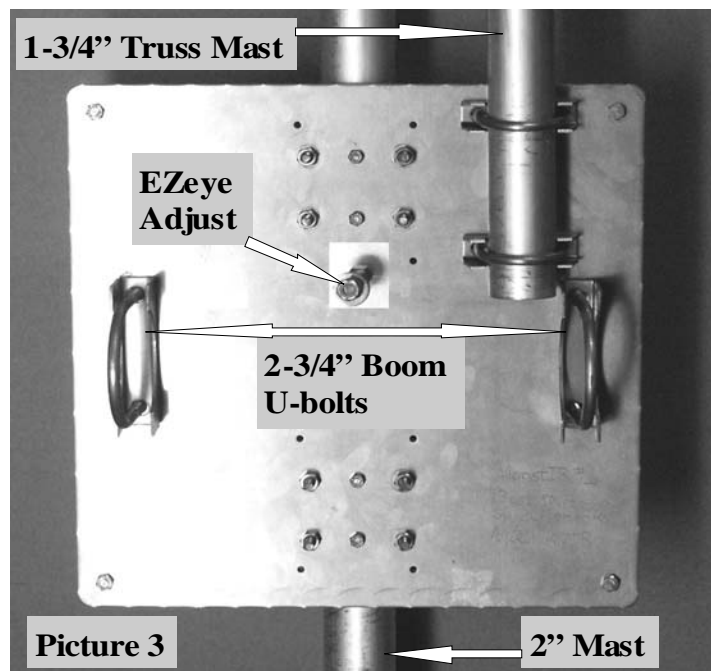

Picture 4

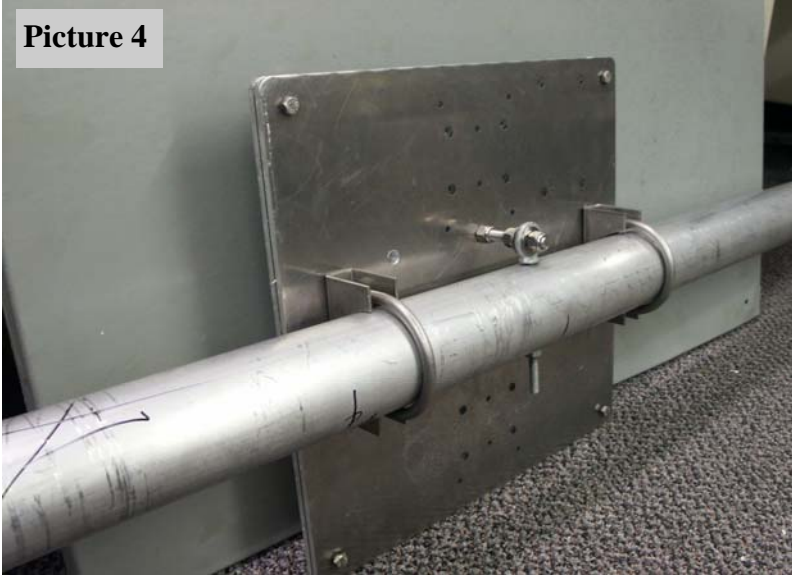

Picture 4.1

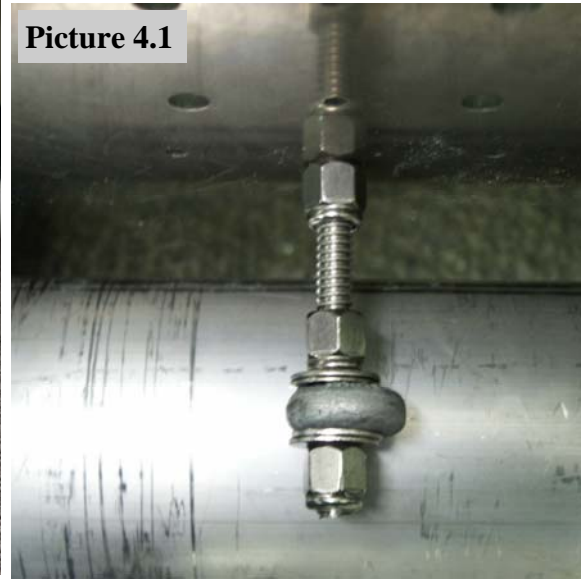

Boom Assembly

The boom was completely assembled and drilled and marked at the factory to assure precision element alignment. You may notice in some cases that on a given splice (**Picture 4.5**) the holes on each side of the splice are at 90 degrees with each other. This is as designed and **not** a mistake. The pre-drilled holes are quite snug and align almost perfectly. The holes are purposely tight so no movement is allowed. Movement will cause work hardening and that leads to boom failure. Therefore, **DO NOT** drill out the holes for more clearance. Thread the bolt in as far as possible, then lightly tap with a hammer to seat the bolt.

If the holes are visibly out of alignment when you are assembling the boom, you probably have the boom pieces put together in the wrong order – or the boom sections that do not have an element bracket on them may need to be rotated 180 degrees. Each boom piece has a number permanently **written**, **scribed** or **stamped** on it. Match each number with the exact same number of a corresponding boom piece. **Picture 4.5** shows joint # 1 markings inside the ring (they must line up). **Figure 1** shows how each boom section is numbered.

Picture 4.5

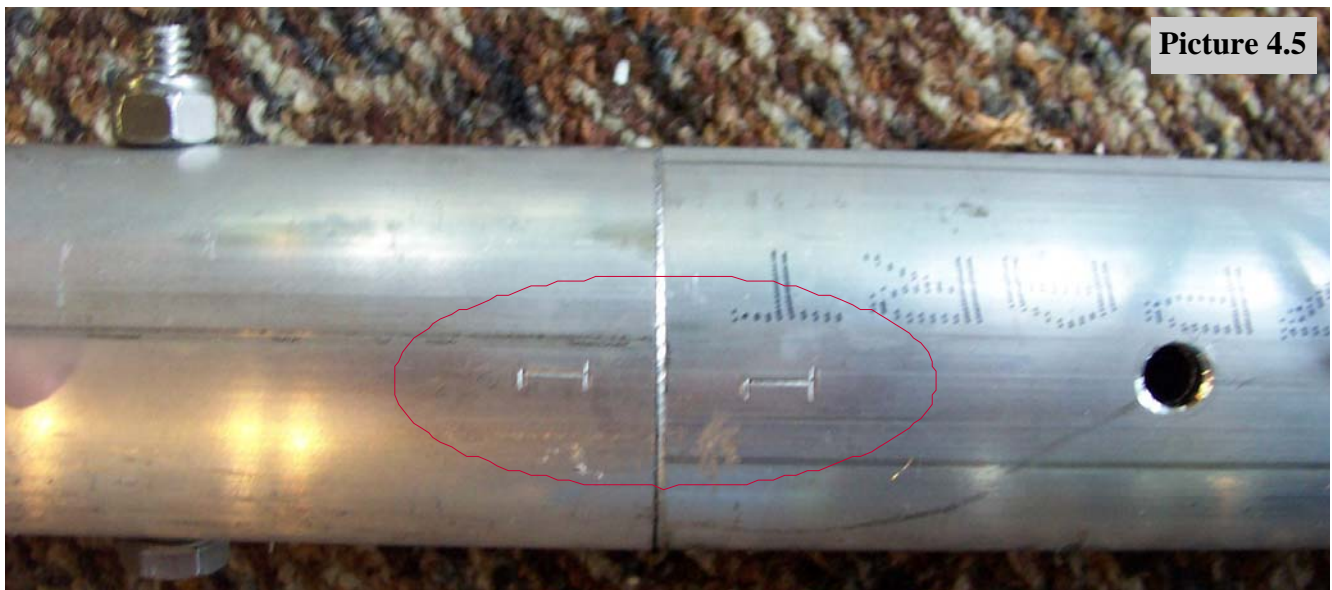

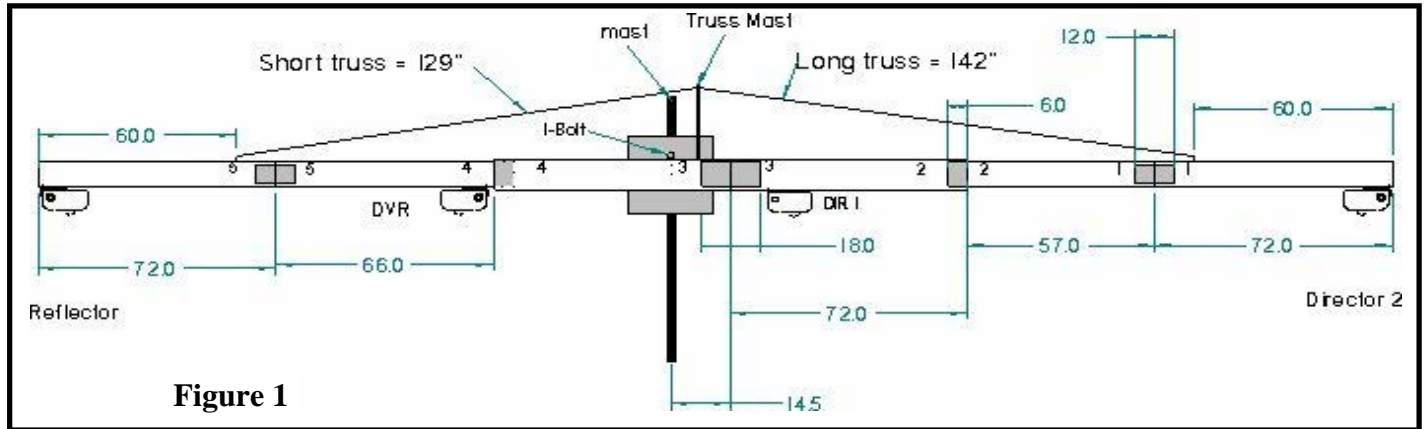
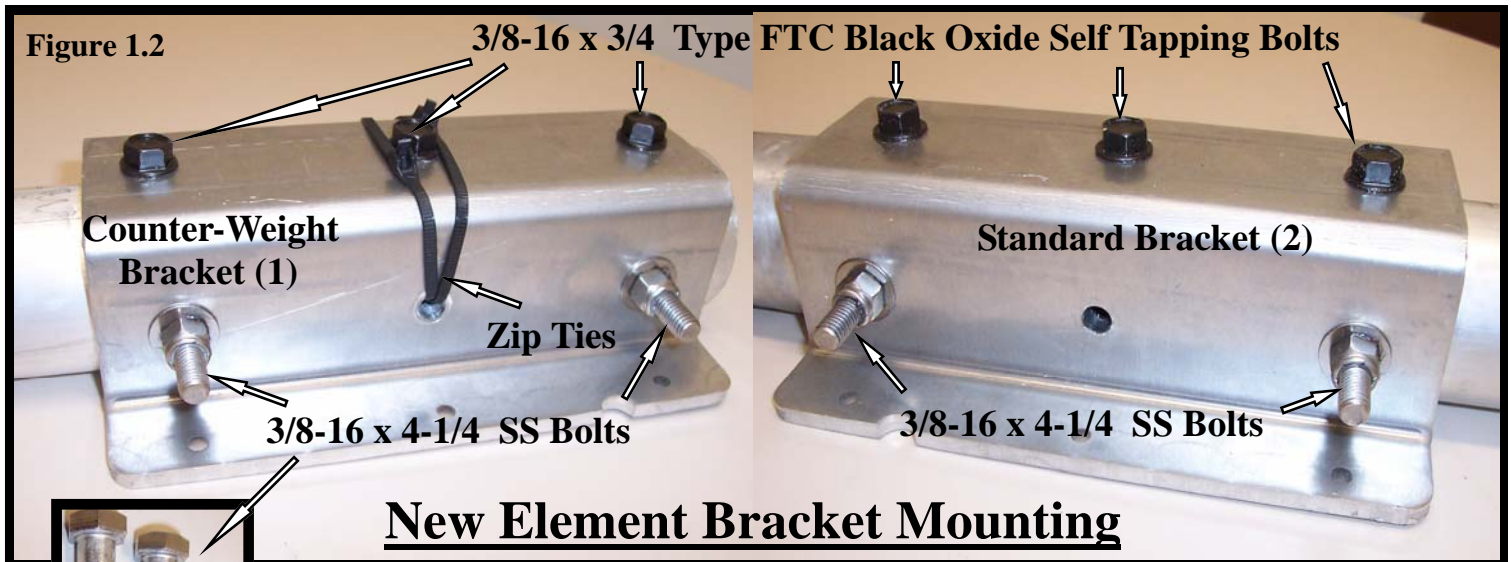

Figure 1

JOINT NUMBER	BOLT SIZE	QUANTITY
1	1/4" x 20 x 3.5 "	6
2	1/4" x 20 x 3.75"	3
3	1/4" x 20 x 3.75 "	6
4	1/4 "x 20 x 3.75 "	3
5	1/4" x 20 x 3.5 "	6
TABLE 1		



We have modified the hardware securing the (3) 40m element mounting brackets to the boom on your new MonstIR antenna (Figure 1.2) as of August 2007.

Counter-Weight Bracket (1):

- Remove zip ties
- Make sure counter-weights clear the hole
- Position vertical truss supports
- Install the included bolt / no washer
- Put 'Connector Protector' on the threads
- Tighten the nut securely

Standard Bracket (2):

- Position vertical truss supports
- Install the included bolt / no washer
- Put 'Connector Protector' on the threads
- Tighten the nut securely



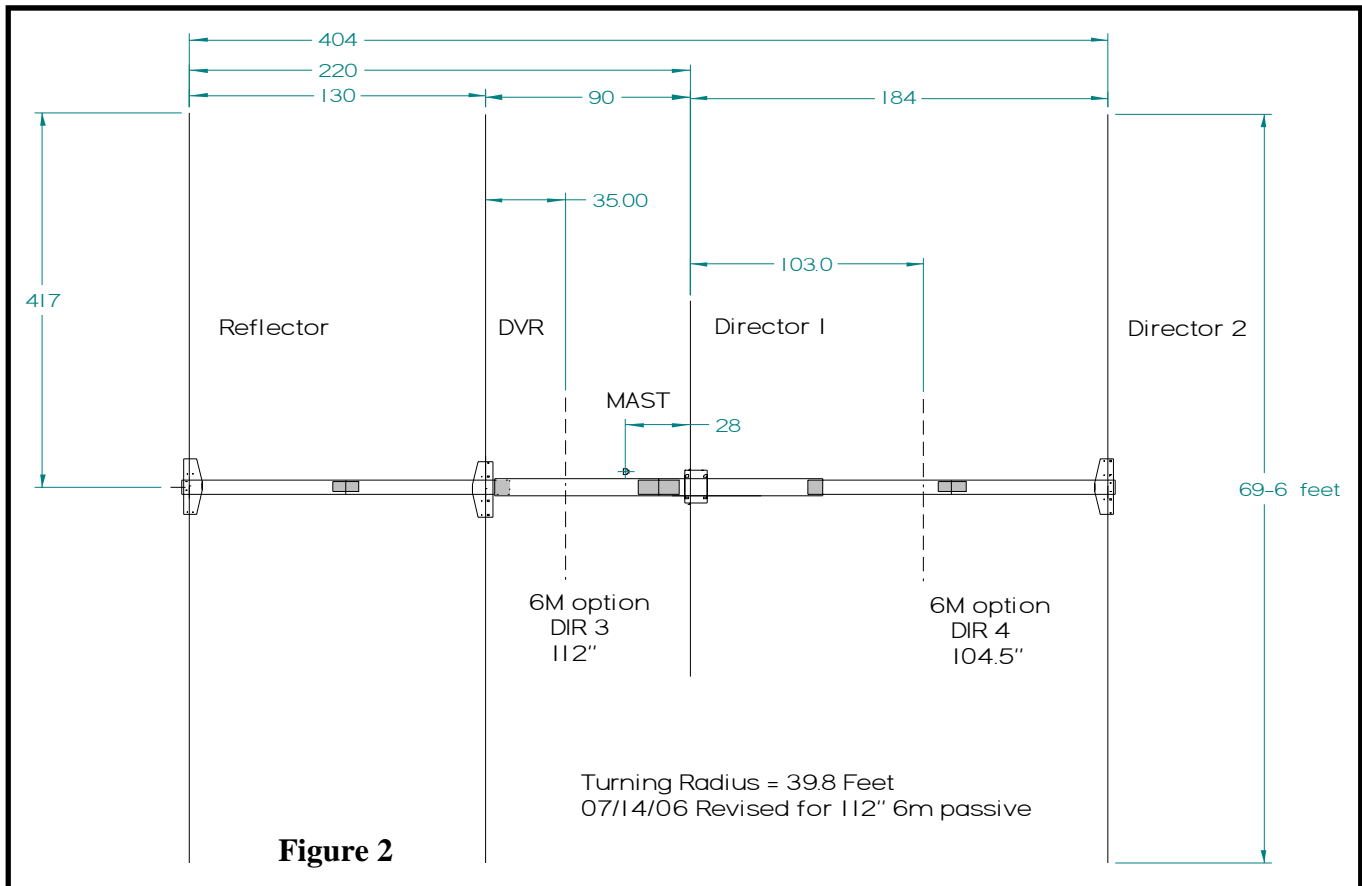

Refer to **Table 1** for selecting proper bolt sizes for each respective connection. A socket wrench is a better choice because the Nylok nuts can't be hand turned so it's a lot more labor intensive without the socket wrench.

1. You will probably find that it is easiest to build the boom on the ground as opposed to mounting it on the temporarily mounted boom to mast plate. Locate and position the six sections of boom tubing and the respective fasteners.

It is advisable to spray a small amount of **WD40** or apply a thin film of anti-seize grease (provided) around the circumference of all male boom splice pieces and on 6" of the 2 1/2" tube that slides into the 2 3/4" tube at joints 2 and 4 before sliding the female sections over them.

Do **NOT** twist the aluminum tubing excessively as that can cause binding.

Apply some anti-seize lubricant to the insides of all the nuts prior to assembly. Assemble the boom by sliding the six sections together in the order shown in **Figure 1**. Insert the required bolts into the holes and loosely attach them with the 1/4" Nylok nuts. Note that, in some cases you may find it necessary to assist the bolts that you are installing by "threading" them in with a wrench. **DO NOT** attempt to hammer them into place, you can lightly tap the bolts in after threading them in as far as possible.

NOTE: The boom section with the number “1” engraved on it has two 3 lb. counter weights in the end of it to make the weight center and provide zero mast torque near the same point on the boom.

2. Orient the vertical bolts so the heads are pointing skyward as shown in **Picture 4.8**. This prevents chafing of the boom truss on joints 1 and 5 and if the nuts did ever come off, gravity would keep the bolts in place.



Picture 4.8

3. There are also three holes 5/16” in diameter and three 5/16” eye bolts. Two are for the boom truss and the third is for the EZ-eye feature that is explained in a later section. The eye of the bolt goes on the topside of the boom with the Nylok nut on the bottom side (**Picture 4.8**).
4. After assembling each of the five joints as shown in **Fig 1**. Tighten the nuts on each bolt and eye bolt securely. Before continuing to the next step, verify that all nuts and bolts, including those installed at the factory, are securely tightened.

Element Bracket Assembly

1. Mount the assembled boom upside down on the mast plate as shown in **Picture 5** using two 2 3/4” u-bolts. Apply anti-seize to the two U-bolts and lightly tighten. The boom will be rotated into the correct position, after the element plates and element housings have been installed.

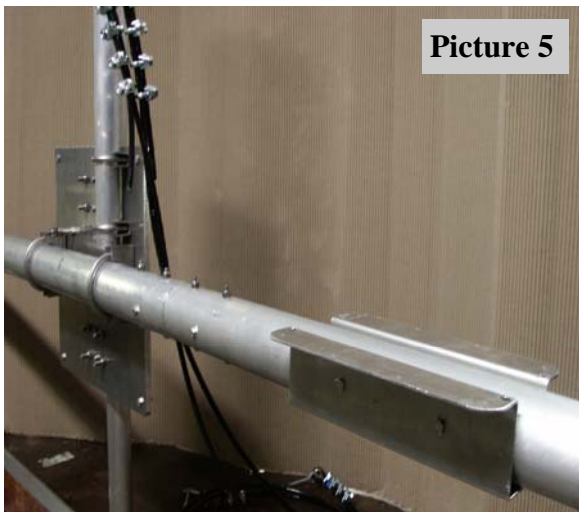

Picture 5



Picture 5.5

2. **Picture 5.5** shows how the element will look when complete and right side up.
3. Mount the three large element plates oriented as shown in **Figure 2** using six $\frac{1}{4}$ " x 20 x 1" flat head bolts. Tighten securely.

NOTE: If the mounting holes for the element plates do not line up with the holes in the element bracket it may be necessary to loosen the horizontal bolts that hold the element bracket to the boom. After mounting the element plates to the element bracket be sure to re tighten the element bracket bolts.

4. Each element plate has eight machined U-saddles mounted to them. There are two types of saddles, notice the difference in height of the semi-circle cutout. One is much lower than the other. Mount the saddles as shown in **Picture 6 & 7** on all three of the large element plates.

There are two saddles used at each of the four position, one must be a “**low**” one and one must be a “**high**” one, never two of the same together. Refer to **Picture 6** for proper assembly. Use eight $\frac{3}{8}$ " x 16 x 4- $\frac{1}{4}$ " bolts to assemble the saddles and truss support bracket as shown in **Picture 7**. Tighten the nuts only enough to keep them from falling off.

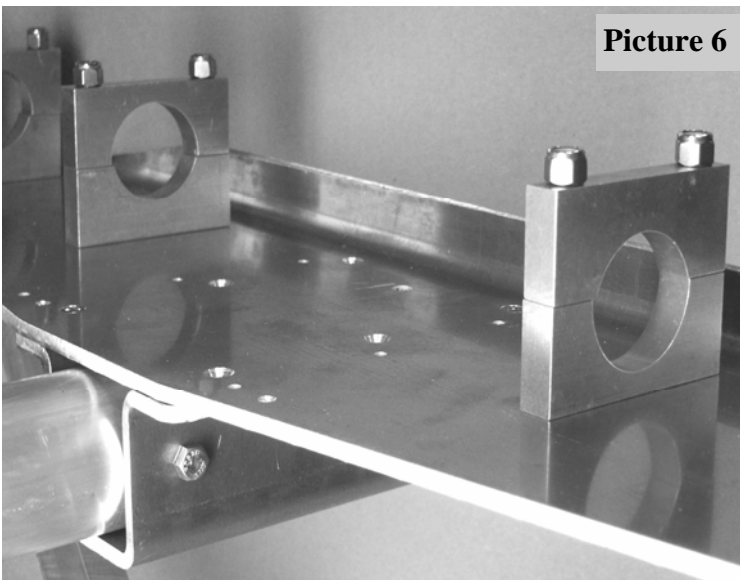

5. When assembling the element housings:

- Before mounting the 40m element housings (**Figure 3**) make sure each one has two rubber boots installed as shown in **Picture 7.4**.
- The 20m housing (**Figure 4**) rubber boots will be installed with the 18' telescoping poles **Picture 32**.
- Remove any packing material in the back of each element housing.
- Do a visual check to verify nothing looks out of order.
- Using the “A” screws install the gasket and back cover on each housing.
- Mount the three 40m element housings to the element plates making sure they are oriented correctly as shown in **Picture 7.4** using the “B” & “C” screws.
- Mount the 20m element housings (**Dir 1**) to the small element bracket. (**Ref Figure 2**)
- Tighten securely.

Note: The Director 1 element plate can be mounted two ways, the correct position puts the element support tubes closest to the mast plate, see **Figure 1 & 2**. The #10-32 screws do not need anti-seize lubricant, they have special lubricated nuts.

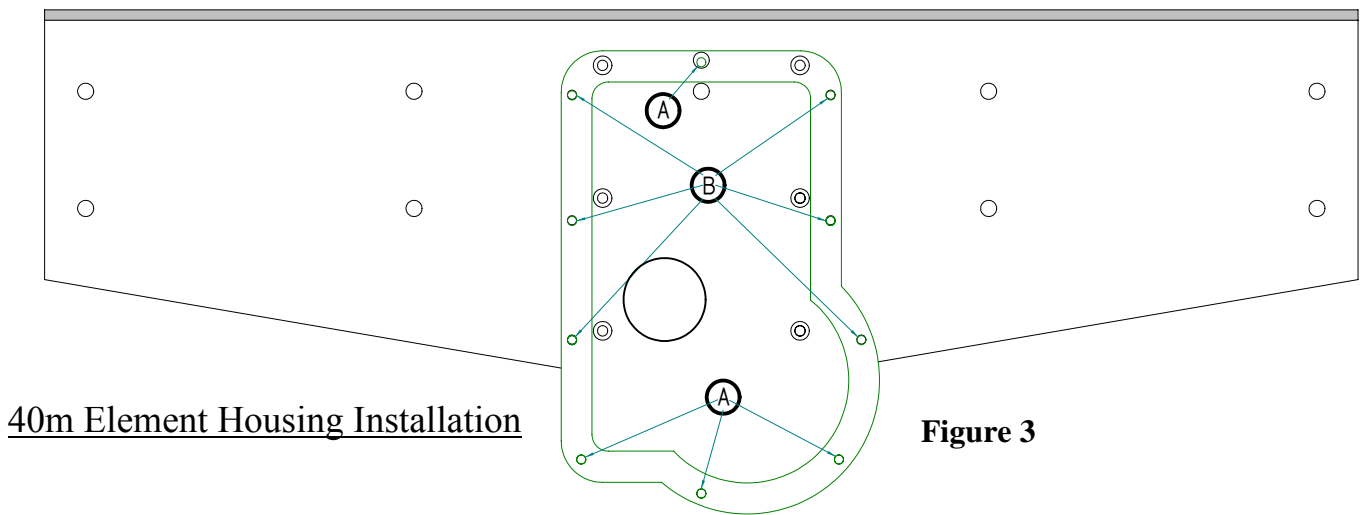

40m Element Housing Installation

Figure 3

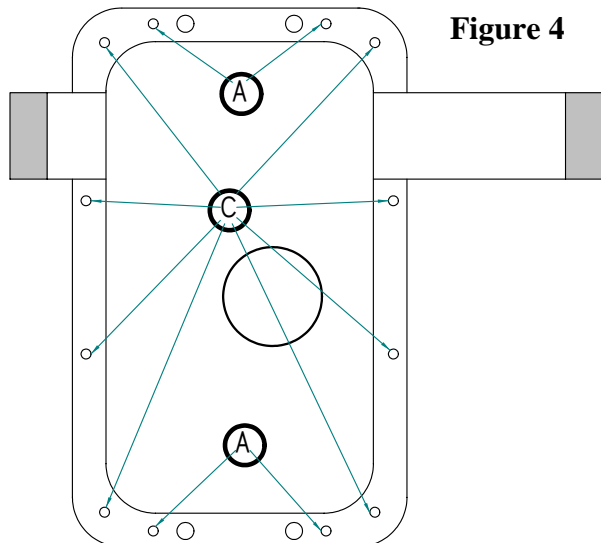

Figure 4

(A) ==> 10-32 X 3/4
(60-0017)

(B) ==> 10-32 X 1-1/4
(60-0072)

(C) ==> 10-32 X 7/8
(60-0061)

20m Element Housing Installation

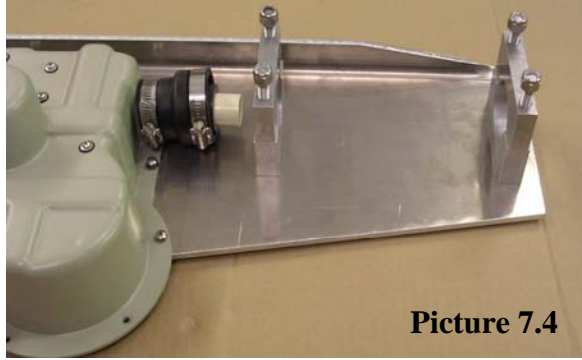

Picture 7.4

6. At this time complete the assembly of the **Ez-eye** by first installing a 3/8" Nylok nut then two 3/8" flat washers on the 3/8"x3" **Ez-eye** bolt, as shown in **Picture 4.1**.
7. Then loosen the two 2 3/4" u-bolts and rotate the boom to its right side up orientation (element housings are on the underside of the boom). You may need to loosen the 2 3/4" u-bolts a bit to get the **Ez-eye** bolt to go into the eye bolt. Put the last two 3/8" flat washers on the bolt and then a 3/8" Nylok nut **Picture 4.1**. Roughly adjust the boom to level by alternately turning the two 3/8" nuts on the **Ez-eye**. Final adjustment can be made on the tower to insure the antenna is level and then securely tighten both nuts against the eye bolt when done.
8. Install the two aluminum vertical element truss angles as shown in **Picture 7.5**. The bottom of the support angles are attached using the middle hole and it's 3/8-16 x 4-1/4" bolt that holds the element bracket to the boom (**Ref. Figure 1.2**). The top is bolted to the element truss support with a 1/4-20 x 1-1/2" bolt. Repeat for the other two large brackets.

NOTE: Director 2 has a zip tie installed in the center hole to keep the two counter-weights from sliding out of position and blocking the bolt hole so keep the boom level when doing Director 2. After removing the zip tie you may need to separate the counter weights using a thin screwdriver to allow clearance to install the 3/8-16 x 4-1/4" center bolt. This bolt will need some effort to install. You will need to thread it through the first side of the bracket/boom then tap it across to the other side of the boom tube and thread it through the second side. Then tap it in all the way put a small amount of 'Connector Protector' on the threads and install and tighten the Nylok nut (no washer required).



Picture 7.5

Install the Boom Truss

Locate:

- Four ¼ in. galvanized thimbles
 - Sixteen ¼ in. galvanized cable clips
 - Two galvanized turnbuckles
 - Two 5/16 x 18 x 4 galvanized eye bolts with Nylok nuts
 - One 5/16 x 18 x 3 ½ bolt and Nylok nut
 - Four 3/8 flat washers
 - One 1 ¾ in. OD x 32 in. boom truss mast
 - Two 1 ¾ in. u-bolts
 - One 151 in. length and one 164 in. length of ¼ in. non-conductive Phillystran Kevlar cable.
1. Mount the truss mast using the 1 ¾ in. u-bolts as shown in **Picture 3** and **Figure 1**.
 2. Using a vise, as shown in **Picture 8**, press the thimble onto the eye bolt. Press the thimble back together as close as possible once it is through the eye bolt. Repeat the procedure to attach a thimble to one end of a turnbuckle (**Picture 9**).

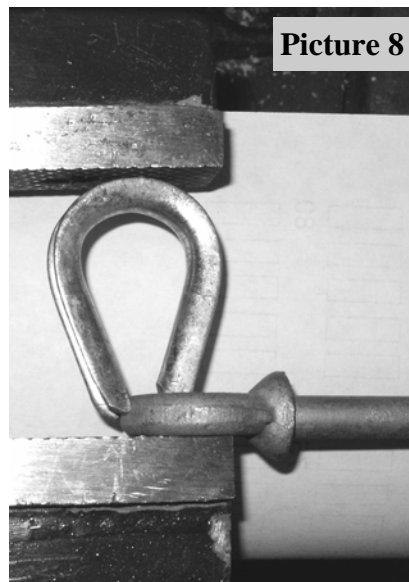

Attach the four cable clips to the Phillystran, with the first one as close to the end of the thimble as possible so the cable will be “locked” in. Attach three more approximately 1” apart as shown in **Picture 9**.

You will want to thread the Phillystran into the cable clip exactly as shown in **Picture 10**, the saddle must be as shown for the clamp to function properly.

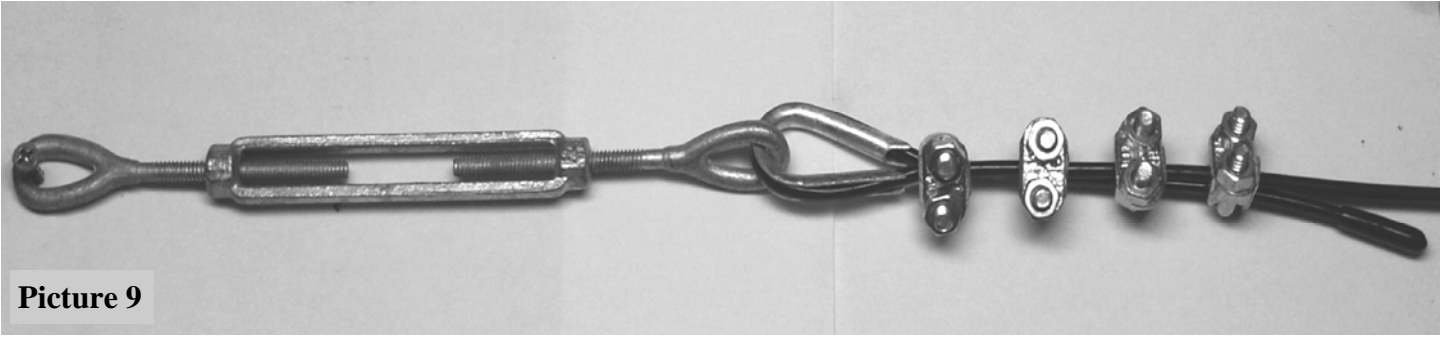

Picture 9

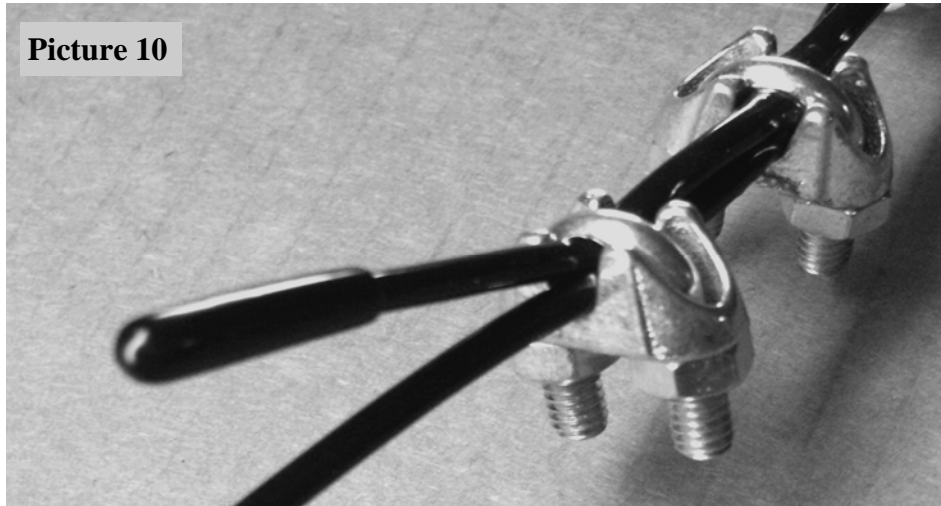

Picture 10

The two truss cable halves are different lengths, one is 142" and the other is 129", both are to be plus or minus .5" for the tolerance. They are measured from the ends of the thimbles, not the ends of the captivated eye bolt or turnbuckle. Use the 151" Phillystran to make the 129" truss cable half, the loop back length will be about 10". Use the 164" Phillystran to make the 142" truss cable half, the loop back length will also be about 10".

Warning: Do NOT completely tighten the wire clips until you have double checked that the lengths are correct, because once the clips are fully tightened the jacket is deformed so much it will expose the kevlar to sunlight if the clip is moved.

A good way to check the cable length is to place supports under each end of the boom so the boom is not sagging but fairly straight and temporarily attach each truss half cable to ensure it is the right length. Do not put the truss under any strain until the clips are all tight.

The nuts may now be tightened to approximately 8ft-lbs of torque each. This cannot be accomplished by holding the clamp and Phillystran in your hand, you will need some small jawed vise grips or a portable vise. A $\frac{3}{4}$ " wrench works even better as shown in **Picture 11**. The vinyl jacket of the Phillystran will be severely deformed where each clamp grabs it, this is normal

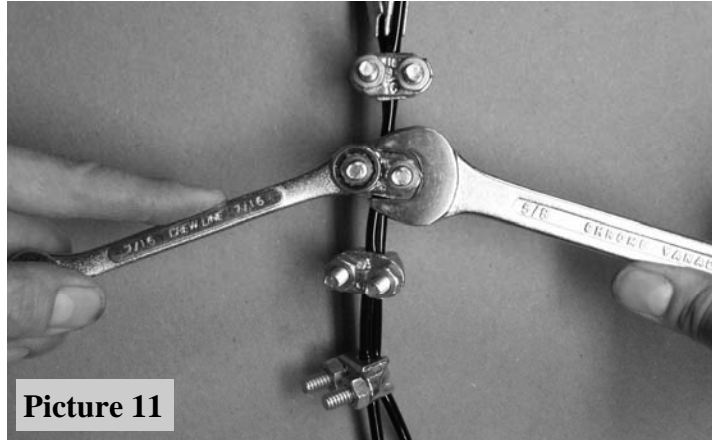

The boom truss halves should look like **Picture 12** when completed. The cable in the picture is shortened for photographing ease.

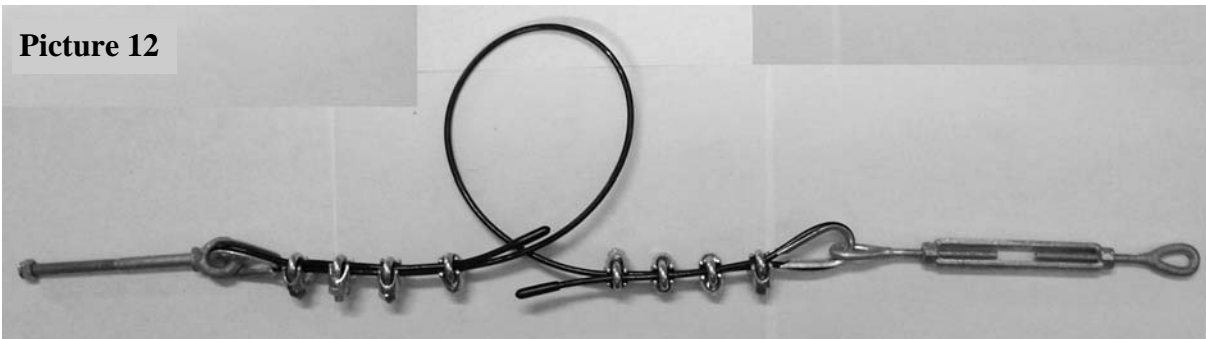

3. Attach the two 3/8" x 16 x 6" turnbuckles of each truss half as shown in **Picture 13** using a 5/16" x 18 x 3 1/2" bolt, a 5/16" x 18 Nylok nut, and four 3/8" flat washers. Adjust both turnbuckles for maximum length. Don't tighten the 5/16" nut so tight the turnbuckles can't move, just barely snug is fine.
4. While holding the Phillystran in one hand (this will prevent the cable from twisting while you tighten the turnbuckles), tighten the turnbuckles using a wrench or screwdriver as a lever, until the boom is evenly supported and level on both sides. Don't be overzealous when tightening the boom truss, you don't want to be pulling it so hard it is bent upward. That not only looks bad, but it puts undue strain on the truss.
5. Locate the four black plastic caps and apply a small amount of silicon adhesive and put one over each cut end of the Phillystran (**Picture 10**).

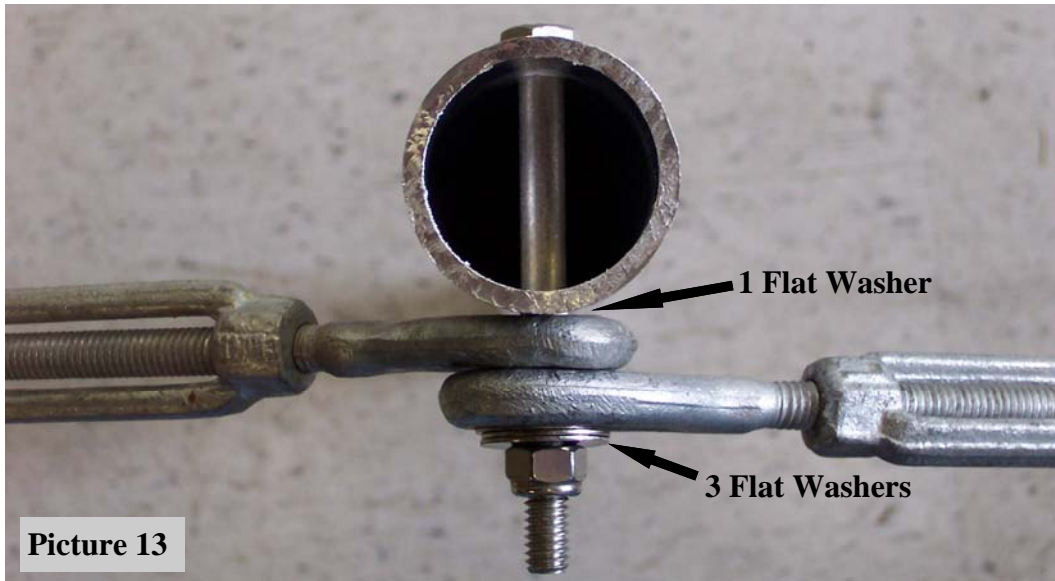

Picture 13

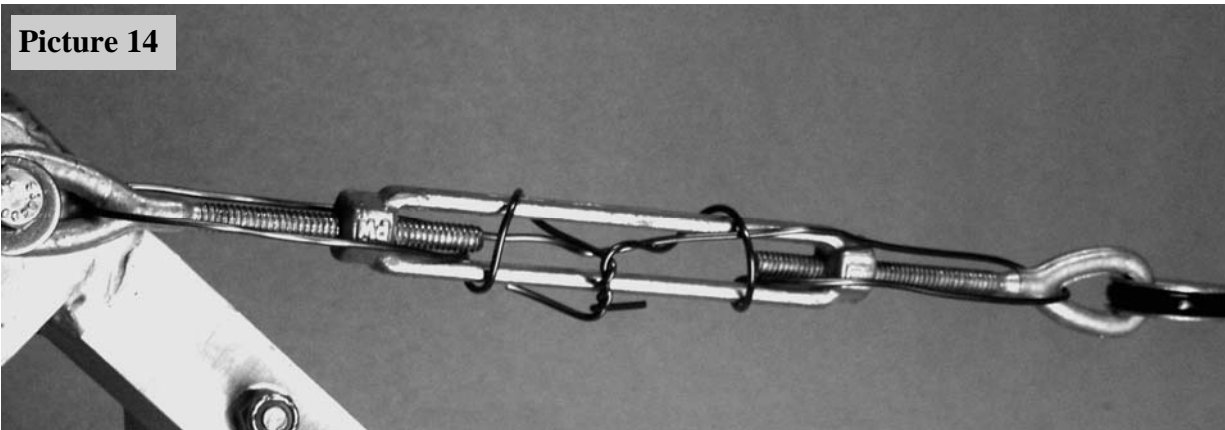

Picture 14

Safety wire each turnbuckle as shown in **Picture 14** to prevent the turnbuckles from loosening in the wind.

[Element Truss Assembly](#)

The three 70' elements have trusses. Each truss consists of two halves just as the boom truss does. All of the element truss halves are the same length, 149" +/- .5".

Materials:

- 48 3/16" galvanized wire clips
- 12 3/16" galvanized thimbles
- 3 1/4" x 20 x 2 1/2" bolts and Nylok nuts
- 6 1/4" x 4" stainless turnbuckles
- 6 3/8" flat washers
- 6 168" lengths of non-conductive 3/16" Phillystran Kevlar cable.
- 6 Element truss u-bolt plates
- 6 2" u-bolts with Nylok nuts

Attach the two 1/4" x 20 x 4" turnbuckles of each truss half as shown in **Picture 14** using a 1/4" x 20 x 2 1/2" bolt, a 1/4" x 20 Nylok nut, and two 3/8" flat washers. Adjust both turnbuckles for maximum length. Don't tighten the 1/4" nut so tight the turnbuckles can't move, just barely snug is fine.

Make sure you measure the length from the end of the thimbles on each end of the truss half. The loop back length at each cable end is about 8.5". The element trusses will be installed after the elements are completely assembled. Each element truss should look like the combination of **Picture 14.1 & 15** when completed. Note that the cable shown in the picture is not really 149", it is a shortened piece for picture taking purposes.



Picture 14.1



Picture 15

Assemble 70' Elements

1. Each of the three 70 foot long elements have a 3/4" CPVC "liner" in the first two sections of each element half consisting of two lengths of CPVC pipe as shown in **Picture 16**. Assemble the two halves using the plastic couplers provided. Glue this joint as shown in **Picture 17** with the CPVC primer/glue provided, you don't want this joint to come apart.



Picture 16



Picture 17

NOTE: If you need to take the antenna apart in the future you can cut the 3/4" diameter plastic pipe (after homing the copper) a minimum of 1 in. beyond the coupler and when you are ready to reinstall the plastic pipe glue in a new coupler .

- Route the CPVC tube through the bracket saddles and a **Mission** rubber boot as shown in **Picture 18 & Picture 21.5**. Make sure you engage the CPVC tube completely into the coupler on the element housing tube (**Picture 19**) and install a # 2 x .25 (**Picture 18.5**) coupler housing screw in the predrilled hole, in the coupler, to secure the CPVC tube. Repeat this process for the other five large elements.

NOTE: Be careful not to over-stress the joint between the two PVC liner halves, you can easily crack the coupler.



Picture 18.5

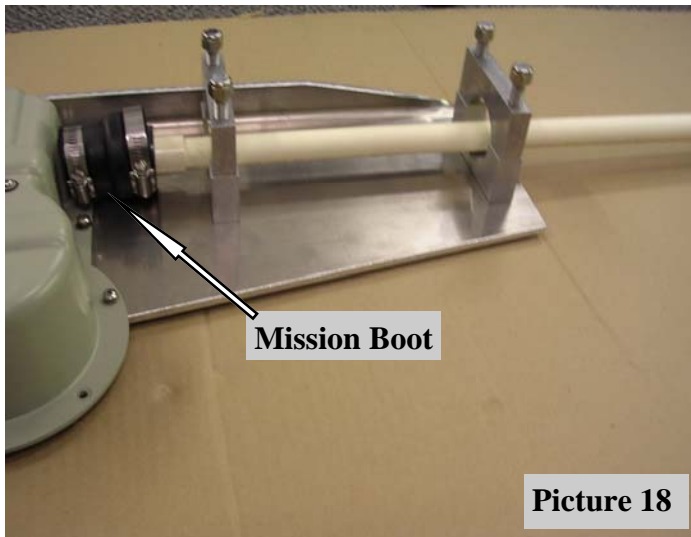

Picture 18

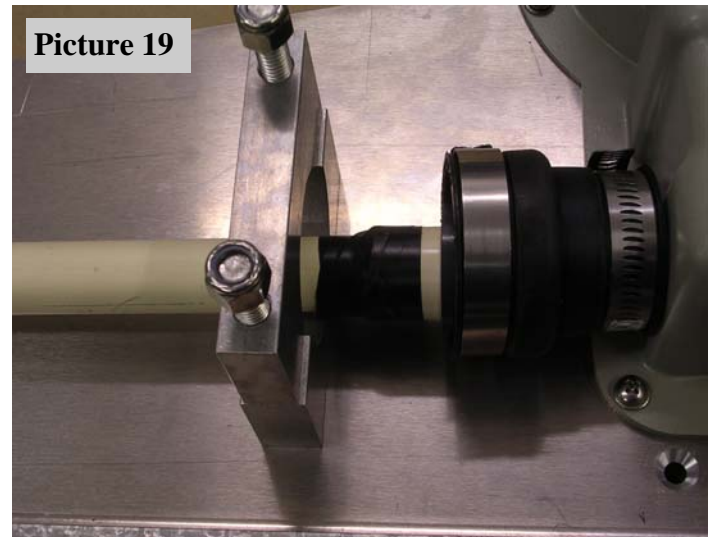

Picture 19

- Being careful not to over stress the connecting coupler, slide the first section of the 2" O.D. element support tube extension over the CPVC tubing. The end with the thin wall aluminum sleeve goes on first, see **Picture 20**. Make sure the aluminum sleeve hasn't slipped and is in the position shown. Position the first element such that the first aluminum ring is just covered by the saddle, see **Picture 21**. When you are sure you have the first element correctly positioned tighten the four 3/8" bolts holding the saddles and truss bracket, but not so tight you crush the fiberglass. Slide the rubber boot into the position shown in **Picture 21** and tighten. The boot keeps water out so make sure it is positioned so the hose clamps can securely clamp it at both ends. Repeat this process for all six long element halves.



Picture 20

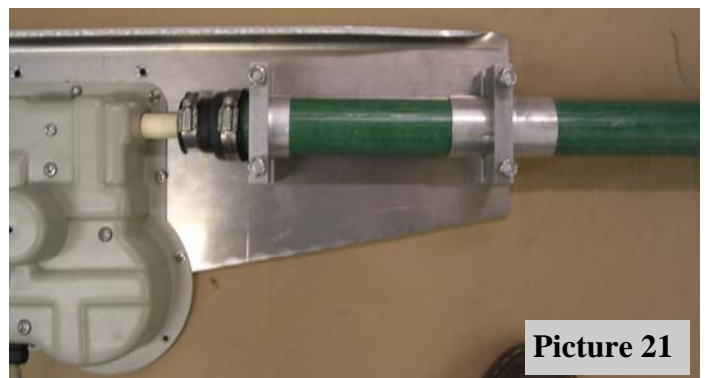

Picture 21

There are two different kinds of rubber couplers (**Picture 21.5**) for the MonstIR Antenna. Below shows the location for the two different rubber couplers.

1. **Mission**- These are smaller rubber boots that are designed to fit to the 40m element housing. You will find **6** of these boots for the joints shown below.
2. **Fernco** – These are the larger thicker rubber boots and are design for coupling the 18' telescoping pole. You will find **8** of these boots for the joints shown below.

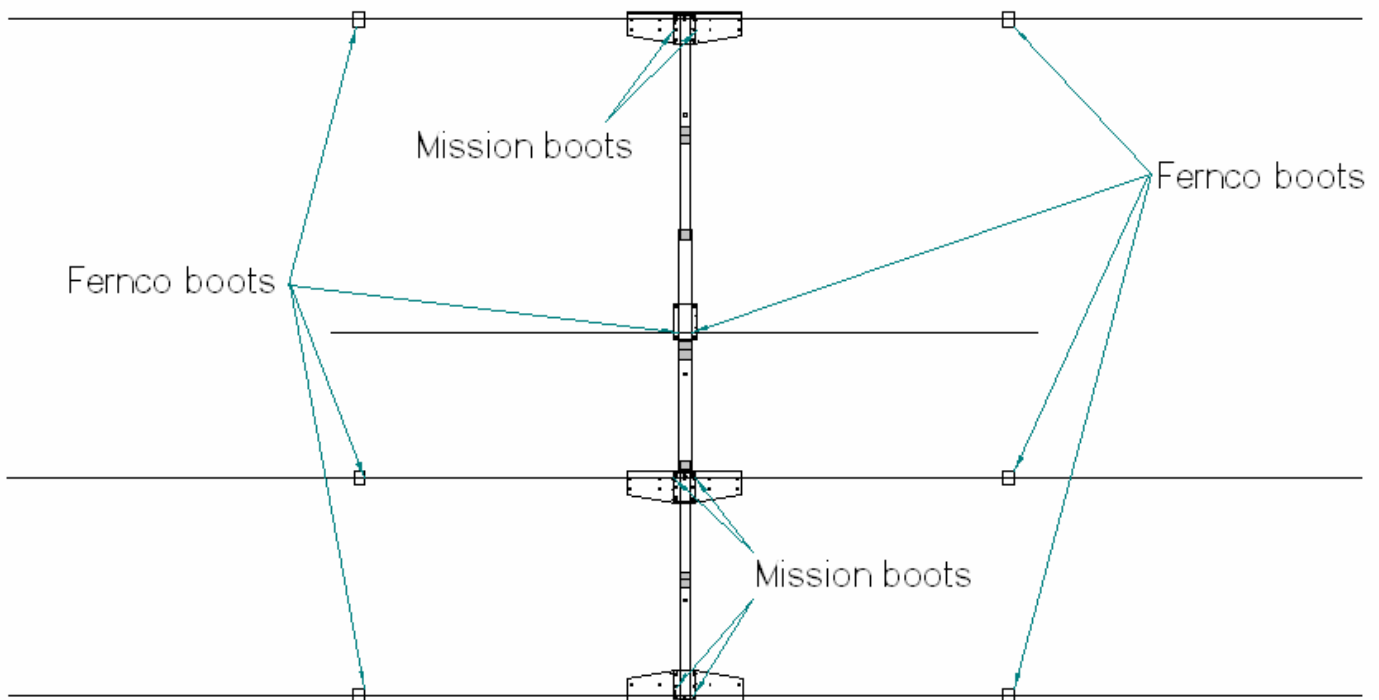

4. Slide the 1 3/4" O.D. second element support tube extension section over the CPVC tubing and mate it with the aluminum coupler on the 2" OD section 1 tube. Make sure the male coupler "bottoms out" so only 3" is left exposed, see **Picture 22**. Install a 2" U-bolt as shown in **Picture 22** and tighten. Make sure to leave room to seal the joint with tape by sliding the U-bolt to one side as shown **Picture 22**. Apply electrical tape as shown in **Picture 23** to seal it and then a layer of pure silicone tape to protect against sunlight. The silicone tape is self-fusing and it only sticks to itself. End your last wrap on top of the silicone tape, not on the aluminum. Repeat for all six element halves.
5. Changes have been made to reinforce the support tube extensions. A self tapping screw has been placed on each tube. These screws need to be placed so that when the antenna is in the air that the self tapping screw heads are oriented so that the heads are facing the sky as shown in picture 22. It is important that the screws are placed properly so that the screws will not attract RF that is given off by the element.

Picture 22

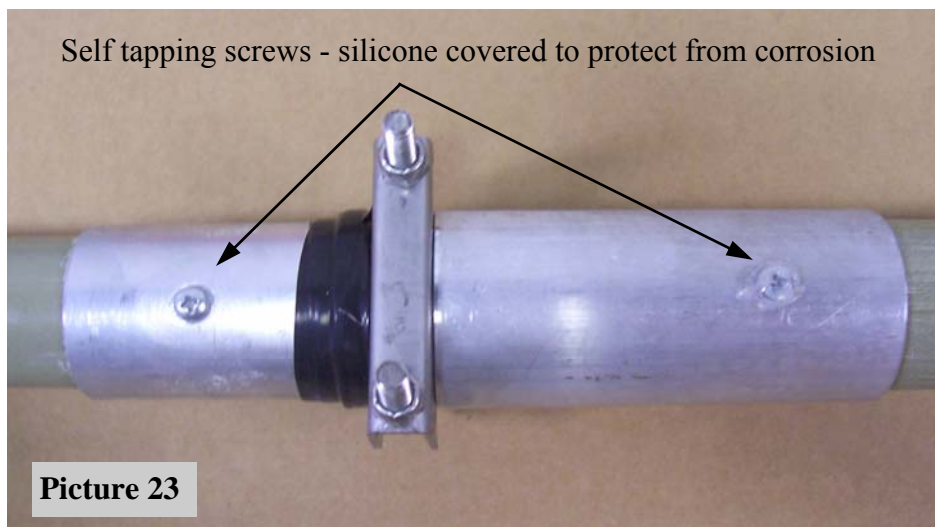
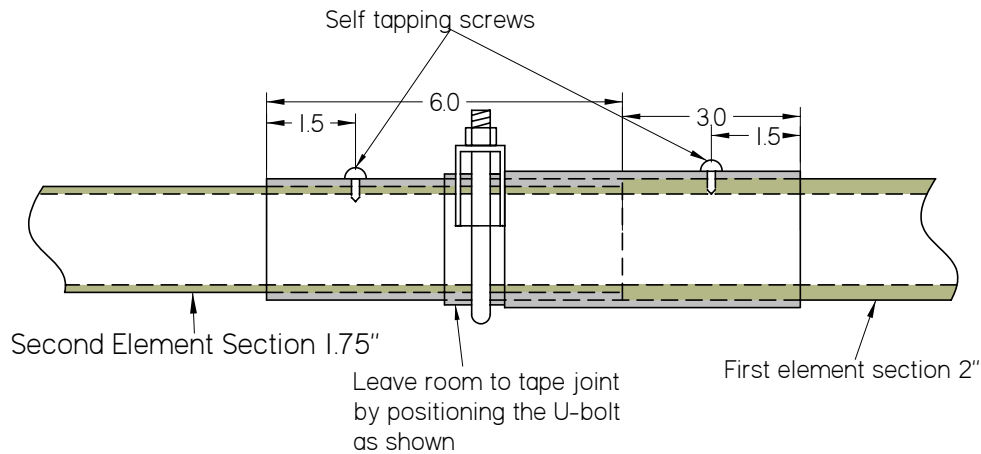

Picture 23

Wiring Elements

Each of the EHUs has a four conductor control cable attached to it using a waterproof strain relief fitting. These fittings were properly tightened at the factory and should not be disturbed. The other end of these control cables have stripped and tinned wires that will be connected to the terminal strips that were shipped inside the ABS terminal tube. Locate the terminal strips (**Picture 24**) and small blue packet of connector protector. Each EHU control cable also has an un-insulated ground wire. It needs to be connected to all of the other un-insulated ground wires using the single position terminal strip as shown in **Pictures 24 & 25**.



Picture 24

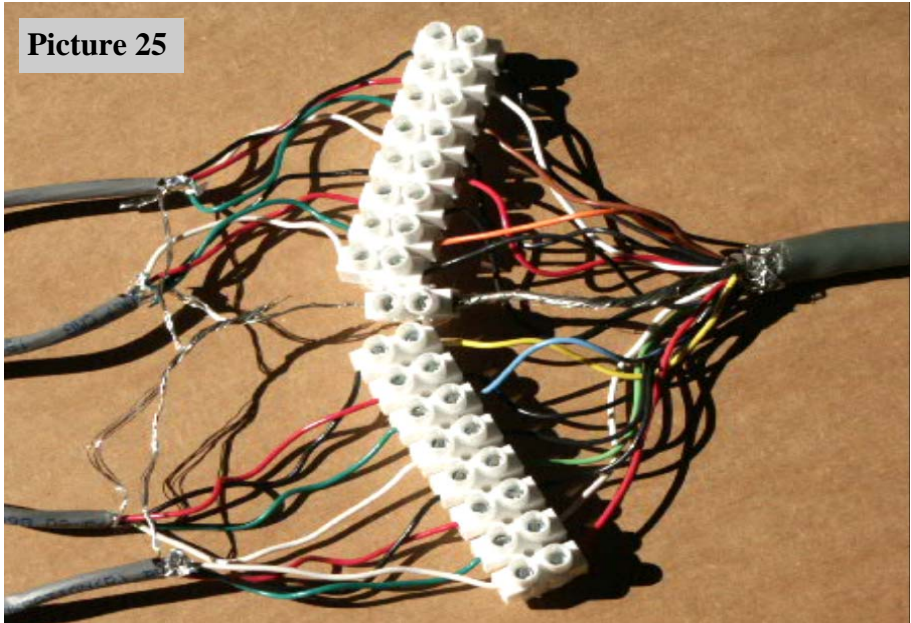

Picture 25

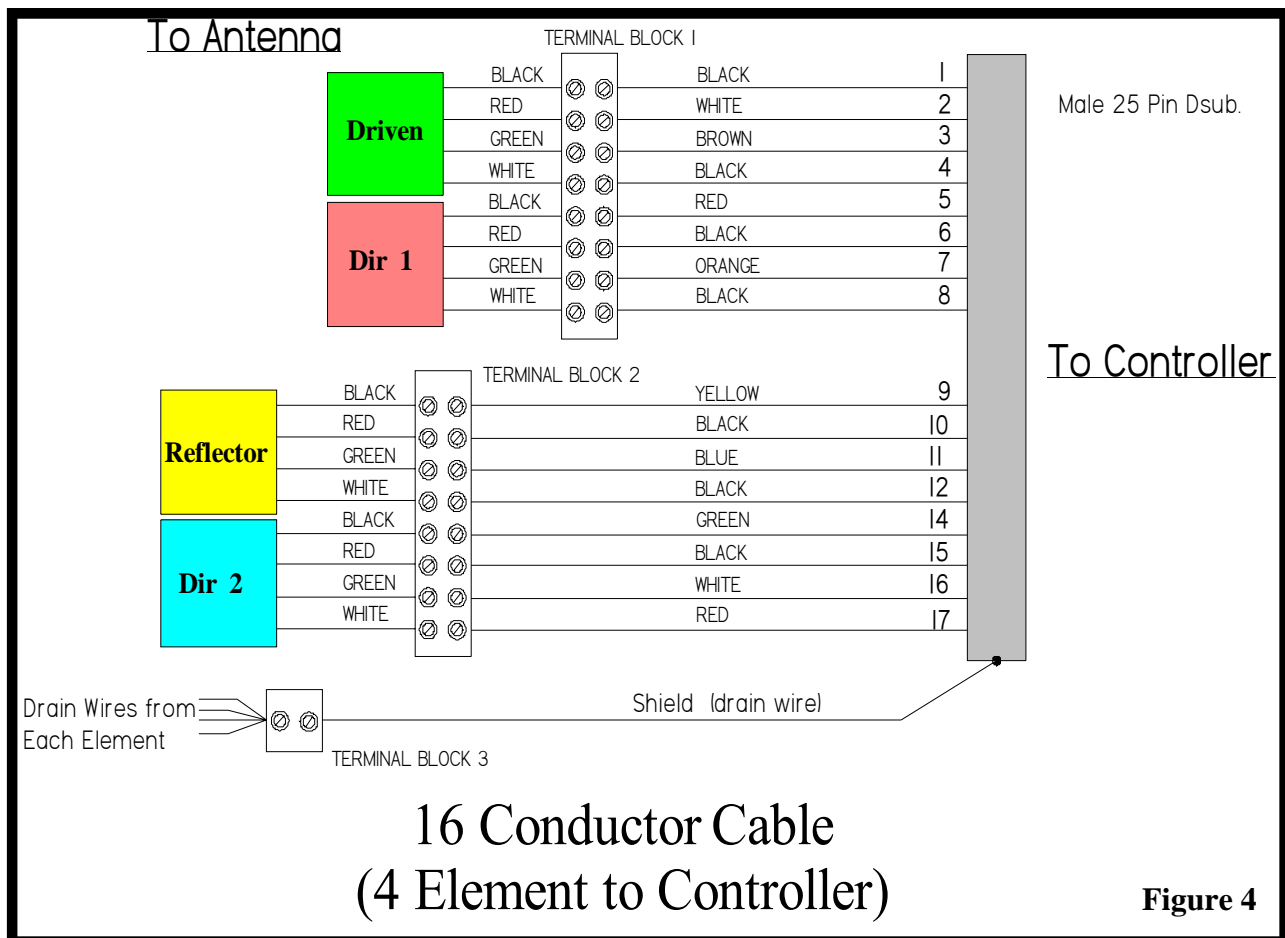
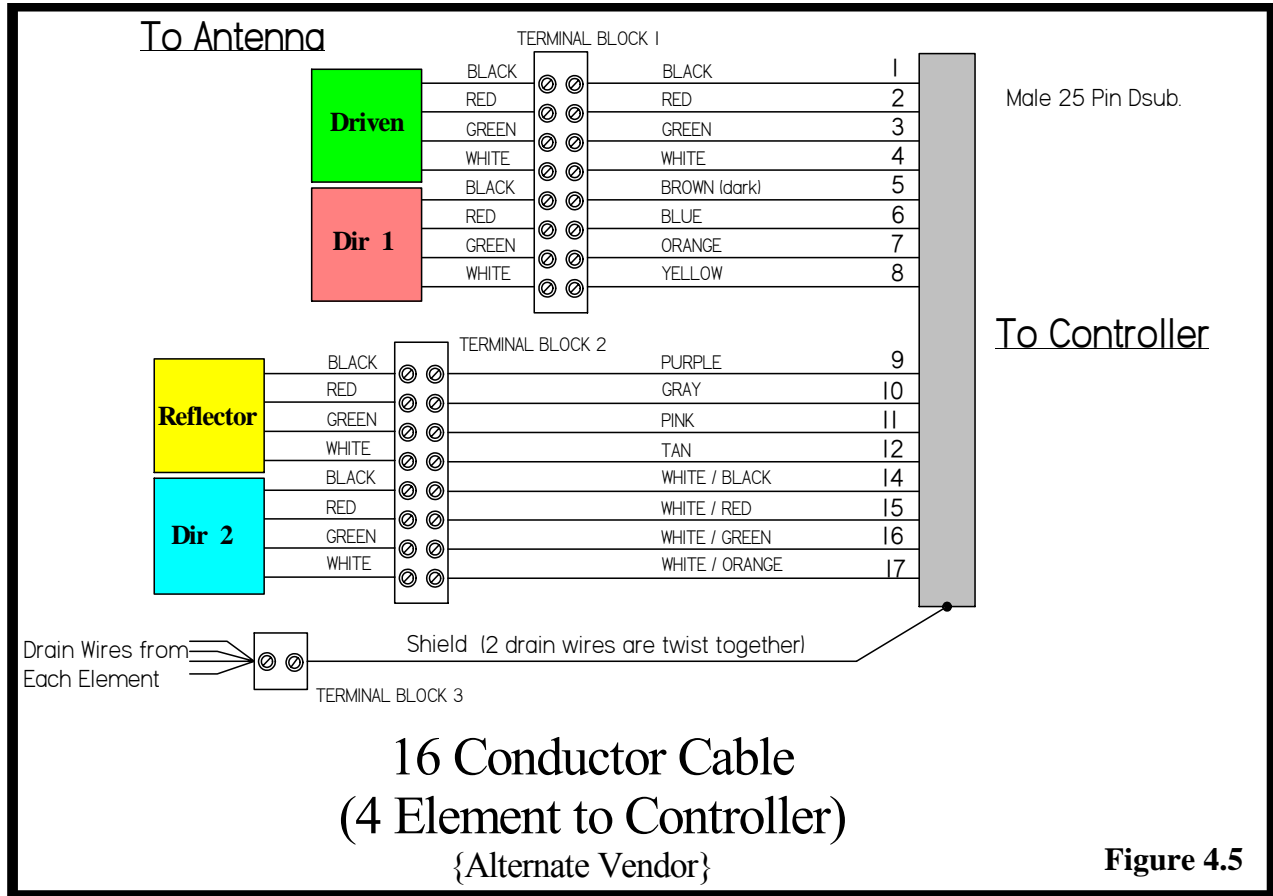

Figure 4

Notice

Soon we will be shipping 16 conductor control cable from a new vendor so we are providing the wiring diagram and color scheme so you have the proper instructions for which ever cable is shipped with your antenna. Both cables are essentially the same except for the wire color scheme.



Mark each four conductor control cable with a felt marker pen or better yet use colored heat shrink or tape to identify each cable. It is easy to get them mixed up after taping them along the boom.

Leave a “drip loop” at each element so water doesn’t run down the cable into the seal on the element box, that’s just asking for trouble.

Pictures 25 & Figure 4 shows how these control cables are wired. Note the single position ground terminal in between the two 8 position terminal strips. The right side shows how the 16 conductor control cable (8 pairs of wires, each pair with colored wire and one black wire) that goes to the shack is connected.

WARNING: Do NOT connect the 16 conductor cable to the SteppIR controller until instructed to do so. The control cable connector has live voltages present even if the power “off” button has been pushed. Shorting the wires of the control cable while connected to the controller with the power supply connected will permanently damage the driver chips.

Note: If you ordered the 16 conductor control cable, it is included in your antenna kit. The required 25 pin connector has been installed on one end and the factory has stripped and tinned the wires on the other end. If you did not order this cable you must supply your own 16 conductor cable and DB-25 pin connector. In such case, a separate connector, back shell and cable wiring drawing have been included in your kit. Call the factory if you would like to order a cable already prepared.

Now start at one end of the boom and tape all the cables snugly to the bottom of the boom so there are no loops or slack cables. This is to prevent the cables from becoming damaged when moving the antenna and installing it on your tower. Secure the 16 conductor cable and coax to the boom about 8" from the coax connector. Refer to **Figure 5** for our suggested cable configuration.

Warning: Be sure to secure the cables before placing the antenna on the tower, as you will not be able to reach the driven element from the tower !!!

Be careful **NOT** to tape the cables over a sharp edge unless you provide extra protection to prevent eventually cutting through the sheath and shorting the wires.

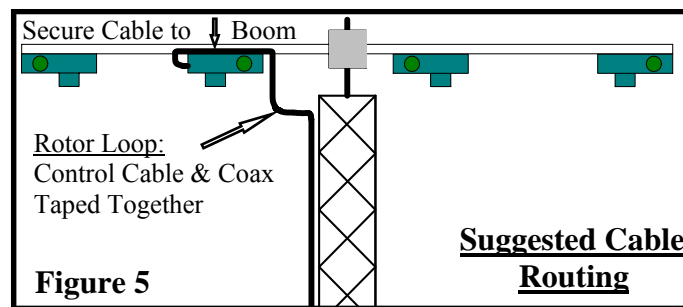

Note: If you do not want to install or remove the antenna with the main coax feed line attached, make a coax jumper that connects to the driven element and goes along the boom back to the mast plate area where it can be connected to the main coax feed line coming up the tower.

Tape the cable every foot or so with electrical tape, we recommend taping it on the bottom side to reduce exposure to UV. When going past an element bracket you can run the cable between the bracket and the boom, it is much cleaner than routing it on the outside of the bracket.

Warning: If you cut the element cables MAKE SURE you measure very carefully .

Carefully review **Picture 25 & Figures 4** before proceeding. First complete the reflector, director and driven element wiring then the 16 conductor cable going to the controller will follow.

Starting with the driven element cable **dip each wire into the connector protector- except the bare ground wire** (a thin coating is sufficient). Insert each of the four colored wire into their respective location on the first 8 position terminal strip. Make sure you don't insert the wire so far in that you are clamping down on just the insulation. **Figures 4** provides the exact location the color codes.

Tighten the set screws as each wire is inserted, but **be careful not to over-tighten these screws.** Repeat this procedure for the first director, reflector and second director cables. Twist the four bare ground wire from the four control cables together, dip them into the connector protector and insert them into one end of the signal position terminal strip. Secure them by tightening the set screw. This completes the control cable wiring for the EHUs.

Locate the 16 conductor cable that goes to the controller. If it is not already coiled neatly, coil it before proceeding. Follow the same procedure as above and connect each colored wire. The 16 conductor cable has eight pairs of wires, each pair is twisted together and taped at the factory.

Warning: It is imperative that these twisted pairs do not get mixed up, or you will have to use a volt/ohm meter to ascertain which pairs match correctly.

Picture 28 shows the respective pairings: black/white; brown/black; red/black; orange/black; yellow/black; blue/black; green/black and white/red. This sequence is exactly the order in which to connect the wires as shown in **Figure 4**. Following the same procedure above connect each colored wire. **Coat each wire end with connector protector. Don't forget to coat the bare ground wire.**

Connect the un-insulated ground wire of the 16 conductor cable to the single position terminal strip that should already have the four grounds, from the four control cables, attached to it.

Position the cables so they are parallel with the two 8 position terminal strips. The single 16 conductor control cable will be on one side and the four 4 conductor cables the other see **Picture 26**. Locate the wiring enclosure tube and plug as shown in **Picture 27**. Put a couple of raps of electrical tape around the wire bundle where it will pass through the notch in the threaded plug to protect the cable sheath from the threads in the tube. Slide the cables and terminals strips into the tube, position the threaded plug cut over the cables and screw the **tube** onto the threaded plug until it is tight.

Fasten the wiring enclosure to the boom using the two (2) stainless steel hose clamp as shown in **Picture 27.5** and position the tube so that the notch in the threaded plug will be to the bottom to permit any moisture that might collect to drain.

There will be a fair amount of excess cable on certain elements. Neatly coil the excess cable and secure it to the boom.

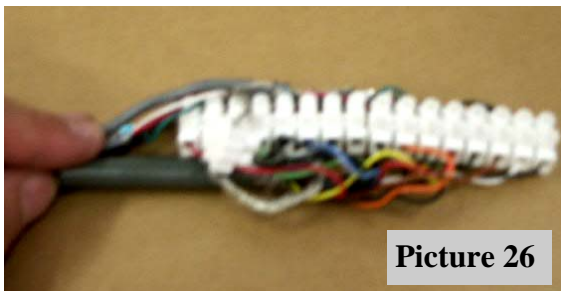

Picture 26



Picture 27

Warning: If you choose to cut the individual 4 conductor element cables to a custom length eliminating the excess loop you must first:

- Know where you will mount the terminal enclosure (Picture 27)
- Measure ACCURATELY before you cut the cables
- Strip and re-tin each wire tip
(DO BE CAREFUL)

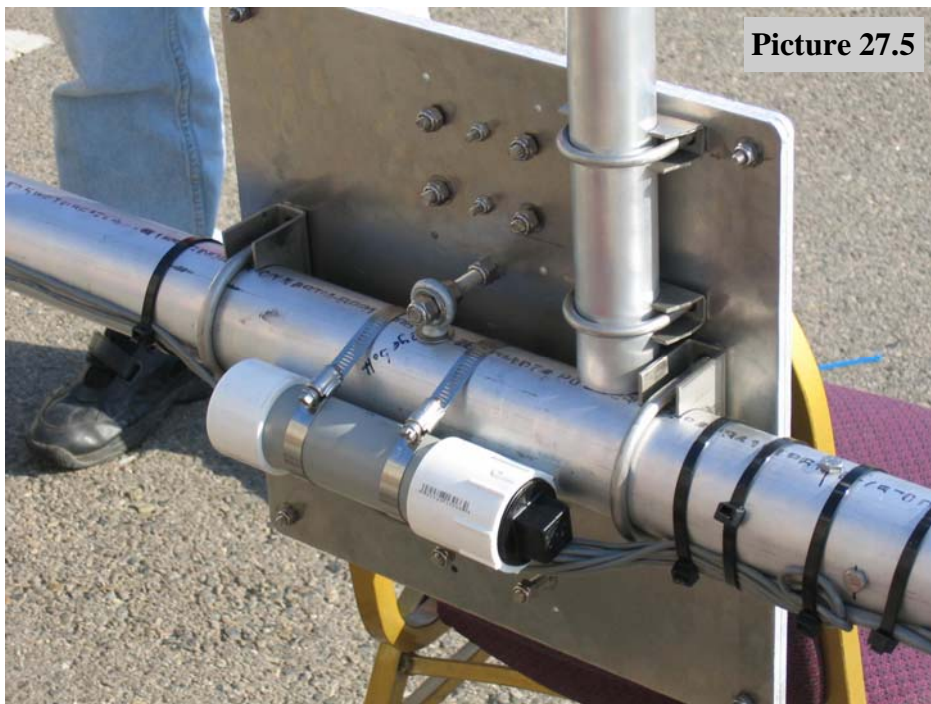

Warning: Do not trap the cables between the clamp and the ABS tubing or overtighten the clamp.

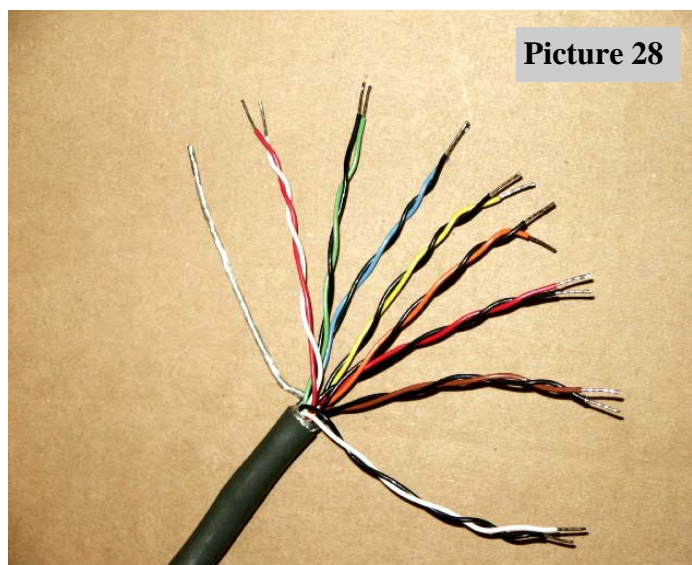

Note: It is strongly recommended, at this point, that you use the “Test Motor” function described in the Operators manual. This will ensure the antenna is correctly wired and functioning before it is mounted on the tower.

Prepare the Telescoping Fiberglass Element Support Tubes

Locate:

- Eight dark green fiberglass telescoping poles (**Figure 29**) *
- Eight black rubber boots with clamps (Fernco)
- Six black rubber boots with clamps (Mission)
- Roll (s) of black electrical tape **
- Roll (s) of black silicone self-curing tape **
- Your tape measure



Rubber Boots

** The quantity of tape provided will depend on the number of elements.



Electrical Tape

Note: The reinforcing rings/sections on the first two pole sections provides extra strength in potential high wind conditions (**Figure 30.5**).

The green fiberglass poles are all assembled in the same manner, and when extended, become element support tubes (ESTs) for the flat strip copper beryllium elements themselves. The copper-beryllium strips are shipped retracted inside their respective element housing units (EHUs).

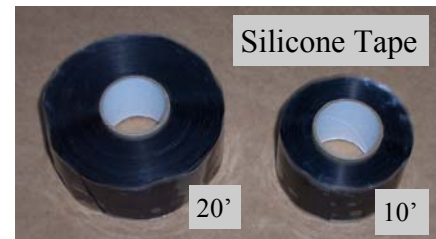

Silicone Tape

20'

10'

Repeat the following procedure for each telescoping pole

Telescope a pole to full length by pulling each section out **firmly** in a twisting motion until it is extended as far as possible. **Each segment is tapered and should lock securely in place when fully extended.** Pole lengths may vary but, when fully extended, each pole must be at least **17 feet 8 inches** in length as measured from the butt end of the pole to the tip (**Figure 29**). **Verify the length for each pole before installation or wrapping the joints.**

If a pole comes up a little short (1/2" to 1") try collapsing the pole and starting over, this time aggressively "jerk" each section out instead of twisting. The pole cannot be damaged and you may gain a minimum of 1/2" or more. If you have trouble collapsing the pole try carefully striking one end on a piece of wood or other similar surface placed on the ground.

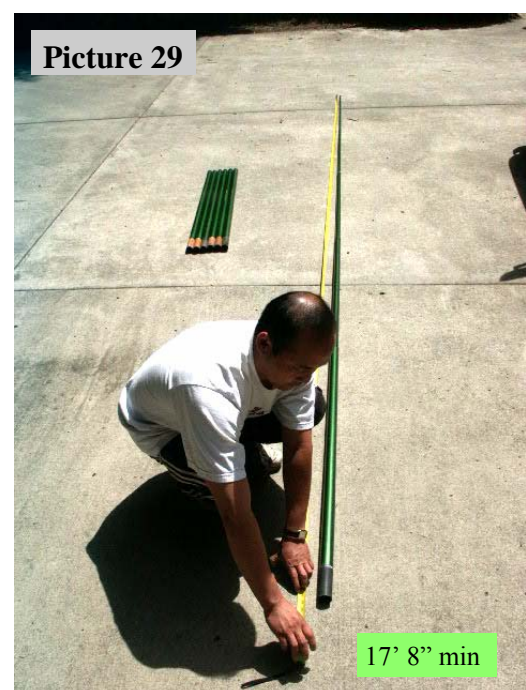

Picture 29

17' 8" min

At the factory when we quality check the poles to verify that they meet minimum length we hold the butt (large) end and whip it like we were casting a fishing pole with considerable force. This procedure can produce a significant difference in the extended length of some poles as a last resort if nothing else works.

DO BE CAREFUL !!!

Warning: Make sure to remove the black rubber plug from the base section of each of the telescoping element support tubes (poles). This is a shipping plug for handling convenience and will seriously damage the copper-beryllium strips and drive mechanisms if not removed.

Check all four sections of each pole for packing popcorn or any other foreign object that could interfere with the copper tape movement.

There are foam plugs glued in the small end of each of the dark green telescoping poles. These plugs allow the poles to breathe preventing the buildup of condensation inside. Do NOT remove, block, cover, plug, cap or in any way inhibit air flow through this foam plug filter.

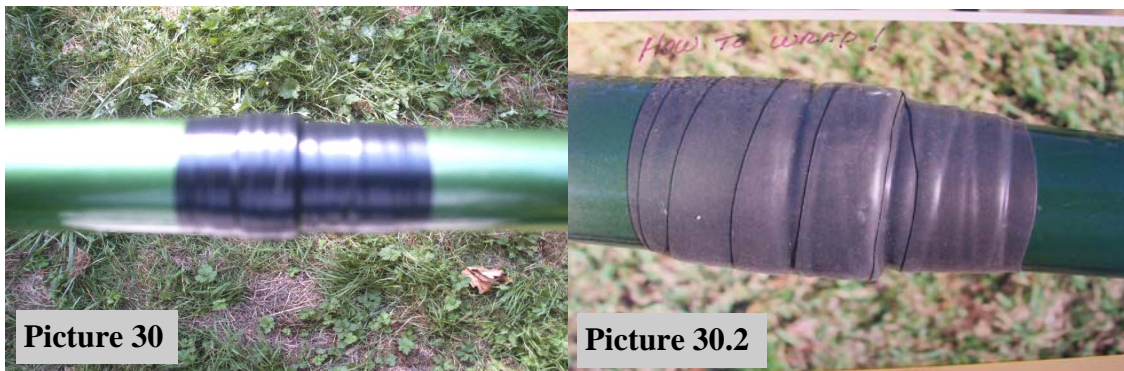

Picture 30

Picture 30.2

Note: The telescoping element support tubes will not all be the same length, this is not a problem as long as they are a minimum of 17' 8". They are interchangeable and can be used in any element position

Next wrap each joint on the fiberglass poles with the all weather electrical tape, see **Picture 30**. Each joint should have at least the full width of the tape on both sides of the joint. Use common sense on the amount of tape or you will not have enough of the silicon tape used later to cover the electrical tape.

Exception: On joints with metal reinforcing rings (**Picture 30.5**), the tape must go further so it extends a minimum of 3/4" beyond the metal ring and onto the fiberglass pole.



Picture 30.5

Apply one complete wrap of electrical tape around the fiberglass tube as you begin, and then work your way across the joint and back using half overlap wraps, **so that the entire area is seamlessly covered**. Carefully stretch and smooth the tape with your fingers as you apply it, especially when you change directions - this will help avoid ripples and have the tape lie as smoothly as possible. At the end of the run, cut the tape with a knife or scissors and press the end onto the pole. Then run your hand over the tape a couple of times to firm up the bonding.

Recommended Lengths for Silicone Tape Wrapping

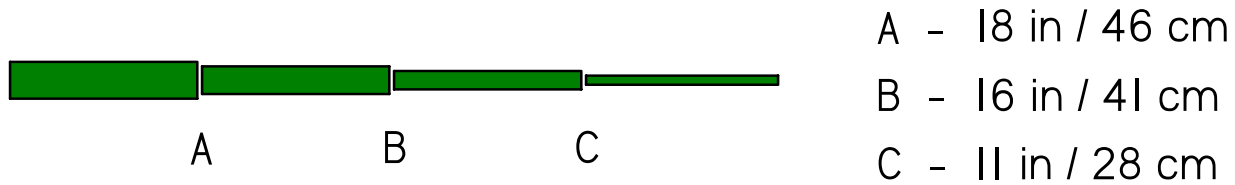

Figure 6

Next, you will weatherproof and UV protect each joint with the black self-curing silicone tape see **Picture 26**. **It is important that you pre-cut the silicone tape to the recommended lengths.** If you do so, you will have more than enough for each joint. Refer to **Figure 6** for proper lengths for each joint. In the event you require more silicone wrap, you can order more from SteppIR. Sometimes it can be found at a hardware store or a marine supply store.

IMPORTANT: Per the manufactures specifications the silicone tape has a shelf life of 12 months before it is used and should be stored in a cool dry environment. Silicone tape will not stick to just any surface. It only bonds to itself. Be sure to remove all the connector protector residue from your hands before handling silicone tape, as that residue will cause the silicone wrap not to adhere to itself in places. Take care to keep the silicone wrap free of dirt or debris. Also, this tape **MUST** be cut. Do not tear it. Wash your hands before completing the following steps.

Position the black silicone tape about 1/2" to the right of the black electrical tape and wrap one layer, **continually stretching the silicone tape a minimum of 100 % its original length**, completely around the pole so the tape fully overlaps itself. Then slowly wrap the silicone tape to the left using half overlap wraps, extending about 1/2" beyond the black electrical tape. When you reach the end, wrap one layer completely around the pole so the tape fully overlaps itself just as you did at the beginning of the wrap. If you are stretching the tape correctly you will get about two layers of tape at each joint. As before, carefully stretch and lay the tape down as smooth as possible. The final joint should look like **Picture 30.2**.

Important: After the silicone tape has been applied, be sure to rub each wrap with your hand several times to ensure that it is flat and has adhered to itself.

[Installing the Fiberglass Element Support Tubes \(EST's\)](#)

The butt ends of the green fiberglass poles may vary slightly in outside diameter. Some of them may have been sanded, while others were not. The colors at the ends will be either beige, or black. The difference in colors has no affect on performance. Do not be concerned if they vary slightly in tightness when being installed on the EHUs. this is normal. All poles are tested for proper fit at the factory prior to shipping. In the event a pole is too tight you can sand it to fit.

The EHTs on the Director 1 EHU have aluminum reinforcing rings attached to provide extra strength in high wind conditions (**Picture 31**) and prevent the boot from ever sliding off. There are 8 EST's, two of them attach directly into the Director 1 EHU. The other six form the last section of each 70' element half.

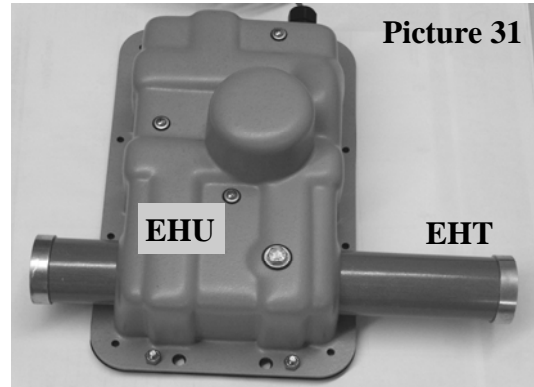

Place a **Fernco** rubber boot (**Picture 21.5**) on the butt end of the EST and insert the butt end of that EST into the Director 1 Element Housing Tubes (EHT) on an EHU, as shown **Picture 32**. **It is very important to ensure that the butt end of the EST firmly bottoms out inside the EHT.** After making sure the EST is seated all the way into the EHT **it is equally important** to push the rubber boot firmly onto the EHT until it bottoms positioning the clamp completely past the aluminum ring (Picture 32a), then tighten the clamp sealing the boot on the fiberglass EHT. After insuring both stainless steel hose clamps are firmly tighten, one over the EHT and the other over the EST, test the connection by pulling and twisting it. There should be no slippage at the joints



NOTE: You should re-tighten each clamp a second time (at least 30 minutes after the first time you tightened them) before raising the antenna to the tower, to be sure that there has been no cold flowing of the PVC material on the boot.

The remaining six EST's are used as the last section of the 70' elements. The EST slides into the end of the 1 3/4" O.D. second section of the big elements (**Picture 32b**). The EST's are attached as described in the previous paragraph covering EST attachment to the Director 1 EHT. The only difference is there is no stop in the 1 3/4" O.D. second section, so you must ensure that you only slide the EST in until the painted surface is flush (**Picture 32b**) with the end of the 1 3/4" tube (about 4"). Repeat with all six 70' element halves.



Picture 32b

Installing Element Trusses

Locate:

- Six 149" x 3/16" element truss assemblies
- Six 2" u-bolts and nuts
- Three 1/4" x 20 x 2 1/2" bolts
- Three 1/4" x 20 Nylok nuts
- Six 3/8" flat washers.

One end of each element truss clamps directly to the 1 3/4" second section of each 70 foot element half as shown in **Picture 33**. Place the bracket at approximately the mid point of the 1 3/4" section. DO NOT tighten the clamp at this time. Leave the clamp loose enough so that it will slide on the pole. Repeat this process for all six truss halves. Now adjust each of the six turnbuckles to maximum length. Bolt each pair of turnbuckles to their element support structure at the center of each 70 foot element as shown **Picture 34**. Don't over tighten the nut, barely snug is just fine. Next go back to each of the six truss clamps attached to the 1 3/4" sections and slide them outward until the Phillystran truss cable is taught then tighten the four clamp bolts.



Picture 33



Finally adjust the turnbuckles as you did on the boom truss to get the elements reasonably straight and level with each other. Again, don't go overboard with having the elements "arrow" straight. The tension goes up dramatically once the element is very nearly straight. Take your time and sight down the boom to get all of the elements horizontally aligned by adjusting each trusses half. Horizontal misalignment is much more noticeable and annoying. Safety wire each turnbuckle, on both the boom truss and element trusses, as shown in **Picture 14** in the boom truss section.

6M Passive Element Installation (Optional)

If you have purchased the optional 6M passive element kit:

Locate: (Ref: **Picture 35**)

- One 6M passive element kit 112.0" (long)
- One mounting kit (long)
- One 6M passive element kit 104.5" (short)
- One mounting kit (short)
- Blue packet of Connector Protector

Using their respective hardware kits (long & short - **Picture 35**) assemble the two 6M passive elements. Identify the ends of the 3/8" tubing that have the shortest distance from the end of the tubing to the drilled hole. Lightly coat the circumference of these ends with a very thin film of the connector protector. Slide the coated ends of the 3/8" tubing into the 1/2" tubing and align the holes.

Note: Verify that the long element measures 112.0" and the short element measures 104.5".

Securely fasten the pieces together with the 6-32x3/4" machine screws and Nylok nuts.

Install the U-bolt on the center bracket as shown in **Picture 36**.

The 6M passive elements should be mounted on the bottom side of the boom, the same as the other elements, using the U-bolt and saddle shown in (**Picture 36**). Using a tape measure, determine the correct passive element placement as shown in **Figure 2**. Be sure to measure from the actual center line of the 6m passive element, NOT from where the U-bolt attaches (**Picture 37**) to the center line of the correct element support tube **Figure 2**. Make sure the elements are aligned with the green fiberglass poles. Tighten securely.

Warning: When attaching the 6m passive to the boom be careful not to trap the element control cable under the U-bolts.



Picture 35



Picture 36

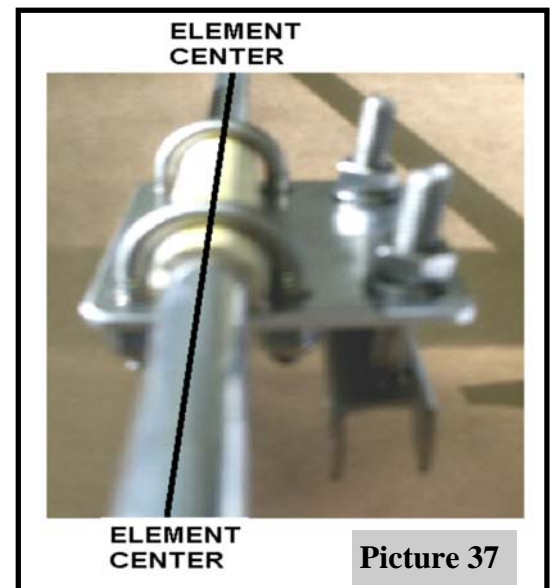

Picture 37

SteppIR Performance

SteppIR antennas are developed by first modeling the antenna using YO-PRO and EZ-NEC. We created antennas that had maximum gain and front to rear without regard for bandwidth.

The antennas that reside in our controllers memory are all optimized for gain and front to rear with a radiation resistance of approximately 22 ohms (16 ohms to 30 ohms is considered ideal for real world yagis. The modeling also takes into account the changing electrical boom length as frequency changes. When the 180 degree function is enabled, a new Yagi is created that takes into account the change in element spacing and spacing and in the case of 4 element antennas creating a two reflector antenna to get maximum use of all elements . The result is slightly different gain and front to rear specifications.

We then go to the antenna range and correlate the modeled antenna to the real world. In other words, we determine as closely as possible the electrical length of the elements. We are very close to the modeled antennas, but it is virtually impossible to get closer than a few tenths of a dB on gain and several dB on front to rear.

There are three factors that make our antennas outstanding performers:

1. They are tuned to a specific frequency for maximum gain and front to rear – without the compromise in performance that tuning for bandwidth causes.
2. They are very efficient antennas with high conductivity conductors, a highly efficient matching system (99% plus) and low dielectric losses.
3. There are no inactive elements, traps or linear loading to reduce antenna performance.

Fixed Element Spacing and the SteppIR Yagi

First of all, there really is no "ideal" boom length for a Yagi. To get maximum gain the boom of a three element beam should be right around .4 wavelengths long. This would allow a free space gain of 9.7 dBi, however the front to back ratio is compromised to around 11 dB. If the boom is made shorter, say .25 wavelengths, the front to back can be as high as 25 dB, but now the maximum gain is about 8.0 dBi. Shorter booms also limit the bandwidth, which is why right around .3 wavelengths is considered the best compromise for gain, front to back and bandwidth for a fixed element length yagi. It turns out that being able to tune the elements far outweighs being able to choose boom length. We chose 16 feet for our three element boom length which equates to .23 wavelength on 20 meters and .46 wavelength on 10 meters, because very good Yagi's can be made in that range of boom length if you can adjust the element lengths. This compromise works out very well because 10m is a large band and F/B isn't as important so you get excellent gain with still very acceptable F/B. When bandwidth is of no concern to you (as it is with our antenna), you can construct a Yagi that is the very best compromise on that band and then track that performance over the entire band. It is this ability to move the performance peak that makes the SteppIR actually outperform a mono-bander over an entire band – even when the boom length isn't what is classically considered "ideal". Bear in mind that a Yagi rarely has maximum gain and maximum front to back at the same time, so it is always a compromise between gain and front to back. This is the same philosophy we use on all of our yagi antennas to give you the most performance available for a given boom length. With an adjustable antenna you can choose which parameter is important to you in a given situation. For example, you might want to have a pile-up buster saved in memory, that gets you that extra .5 – 1.0 dB of gain at the expense of front to back and SWR – when you are going after that rare DX!

[RF Power Transmission with the SteppIR Yagi](#)

The RF power is transferred by brushes that have 4 contact points on each element that results in a very low impedance connection that is kept clean by the inherent wiping action. The brush contact is .08 in thick and has proven to last over 2 million band changes. The copper beryllium tape is .545 inches wide and presents a very low RF impedance. The type of balun we are using can handle tremendous amounts of power for their size because there is almost no flux in the core and they are 99% efficient. That coupled with the fact that our antenna is always at a very low VSWR means the balun will handle much more than the 3000 watt rating, how much more we don't know. Jerry Sevicks book "Transmission Transformers" (available from ARRL) has a chapter (Chap. 11) that discusses the power handling ability of ferrite core transformers.

WARNING: WHEN OPERATING WITH MORE THAN 500 WATTS, DO NOT TRANSMIT WHILE THE ANTENNA IS CHANGING BANDS. A MISMATCH AT ELEVATED WATTAGES MAY CAUSE DAMAGE TO THE DRIVEN ELEMENT.

[Balun / Matching System](#)

The SteppIR has a matching system that is included in the 2 element, 3 element, 4 element and MonstIR Yagi (a balun is available as an option on the dipole). Our antenna designs are all close to 22 ohms at all frequencies, so we needed a broadband matching system that would transform 22 ohm to 50 ohm. We found an excellent one designed by Jerry Sevick, that is described in his book "Building and Using Baluns and Ununs".

Our matching network (balun - **Picture 38**) is a transmission line transformer that is wound on a 2.25 inch OD ferrite core that operates with very little internal flux, thus allowing it to function at very high power levels. The transformer includes a 22 ohm to 50 ohm unun and a balun wound with custom made, high power, 25 ohm coax for superior balun operation. Jerry has espoused these transformers for years as an overlooked but excellent way to match a Yagi, he would probably be proud to know they are being used in a commercial Yagi. This matching network does not require compressing or stretching a coil, or separating wires to get a good match – something that can easily be bumped out of adjustment by birds or installation crews.

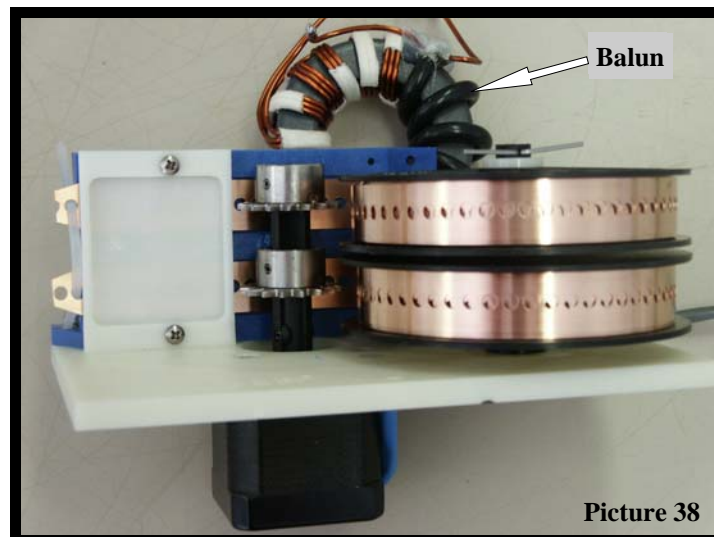

Picture 38



Limited Warranty

These products have a limited warranty against manufacturer's defects in materials or construction for two (2) years from date of sale. Do not modify this product or change physical construction without the written permission of SteppIR Antennas Inc. This limited warranty is automatically void if the following occurs: improper installation, unauthorized modifications, physical abuse or damage from severe weather, beyond the manufacturer's control. Manufacturer's responsibility is strictly limited to repair, or replacement of defective components. The shipping instructions will be issued to the buyer for defective components, and shipping charges will be paid for by the buyer to the manufacturer. The manufacturer assumes no further liability.

*Stepp***IR**™

Antenna Systems

Yagi • Dipole • Vertical

www.steppir.com



Thank you for choosing SteppIR!!